

X-100 SQ

Instrucciones de instalación
Assembly instructions
Instructions de montage
Prescrizioni di montaggio

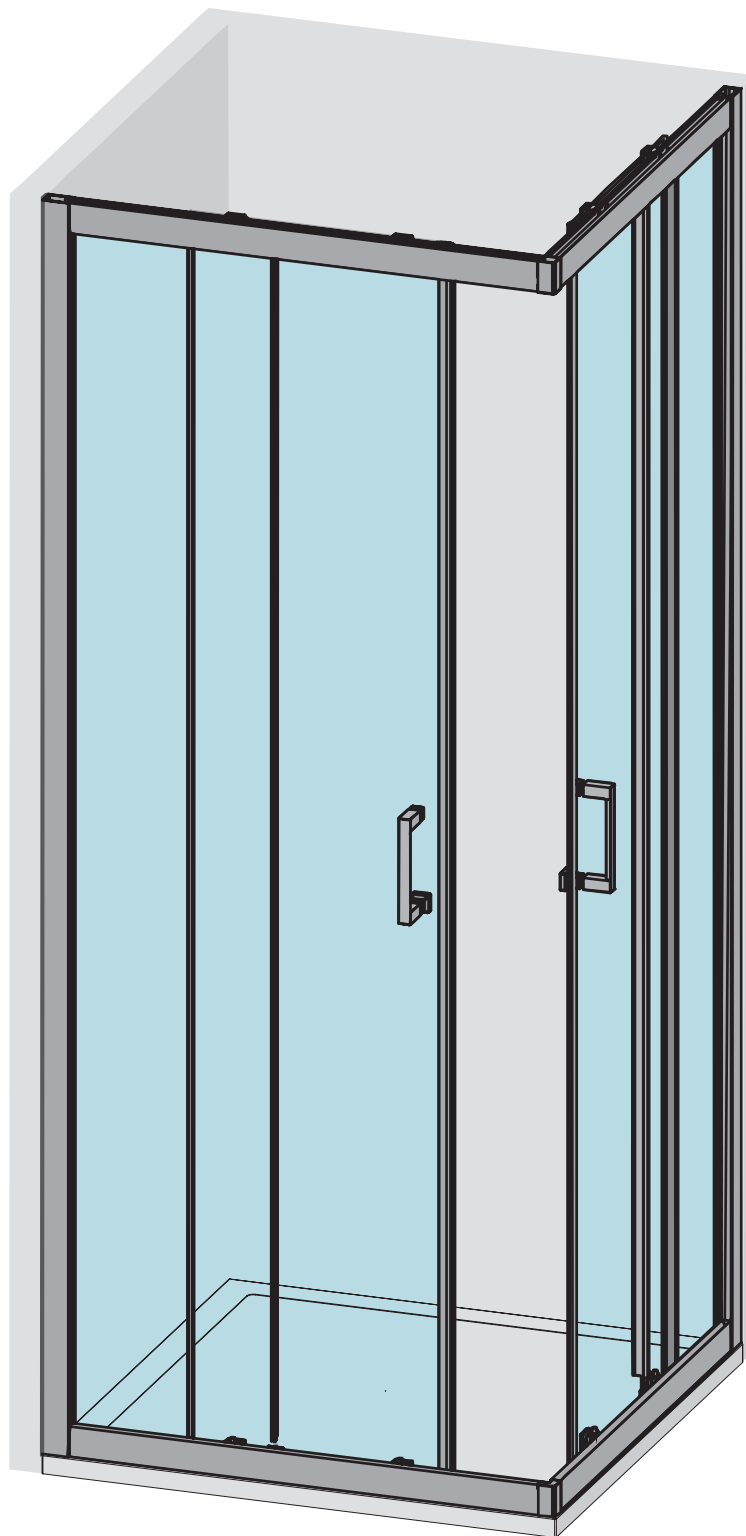

www.mundilite.com

Apdo. de Correos 72

C/ Malvasia Parc. 9 y 11 - Polígono Industrial Pino Blay - 46380 Cheste - Valencia - Spain

Telfs +34 96 251 28 94 / +34 96 070 23 81

email: admon@mundilite.com





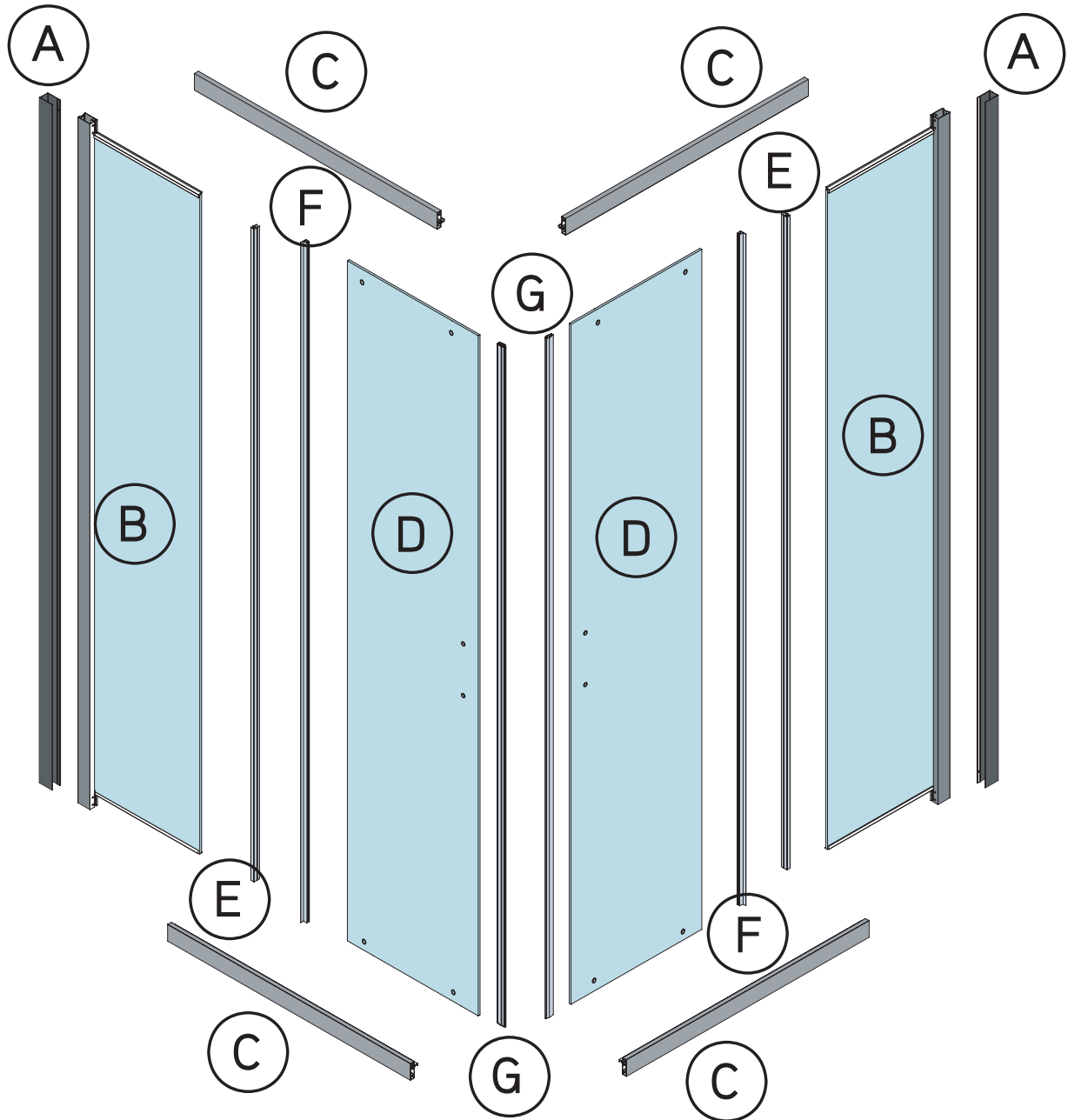

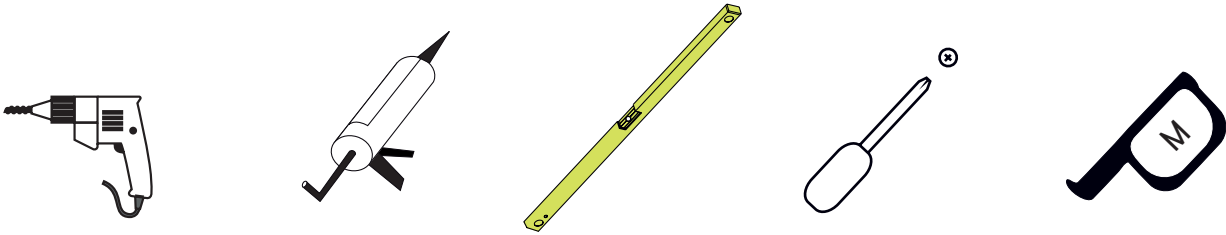



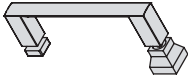

mundilite

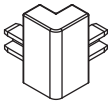
X-100 SQ

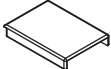
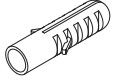

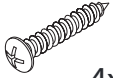

Equipamiento / Features / Équipement / Capitolato

Ref.		Quant.	Ref.		Quant.
H.		1x2 Pc.	O.	 4x12	6x2 Pc.
I.		2x2 Pc.	P.		4x2 Pc.
J.		1x2 Pc.	Q.		4x2 Pc.
K.		1x2 Pc.	R.		1x2 Pc.
L.		3x2 Pc.	S.		1x2 Pc.
M.	 4x30	3x2 Pc.	T.		2x2 Pc.
N.	 4x20	4x2 Pc.	U.		2x2 Pc.

X-100 SQ

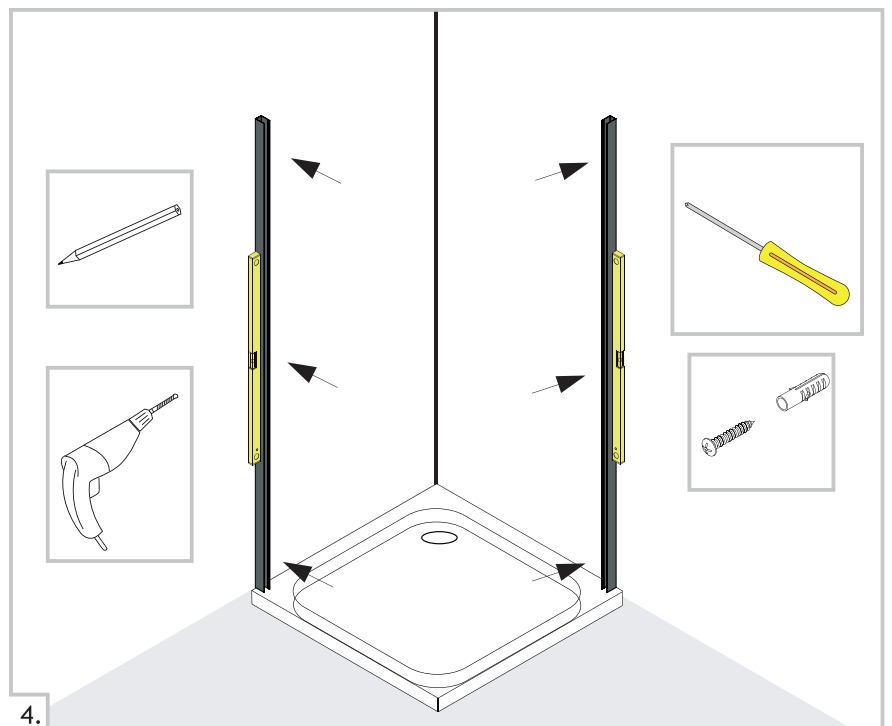
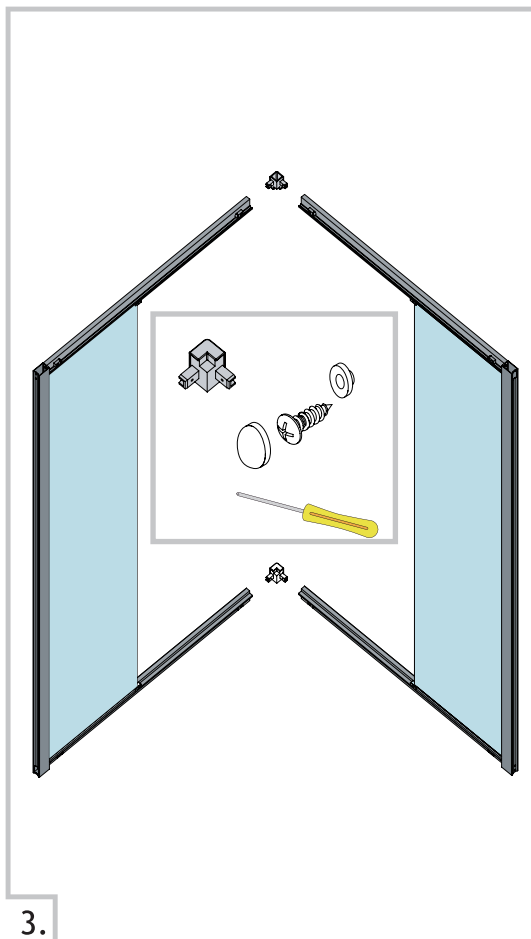
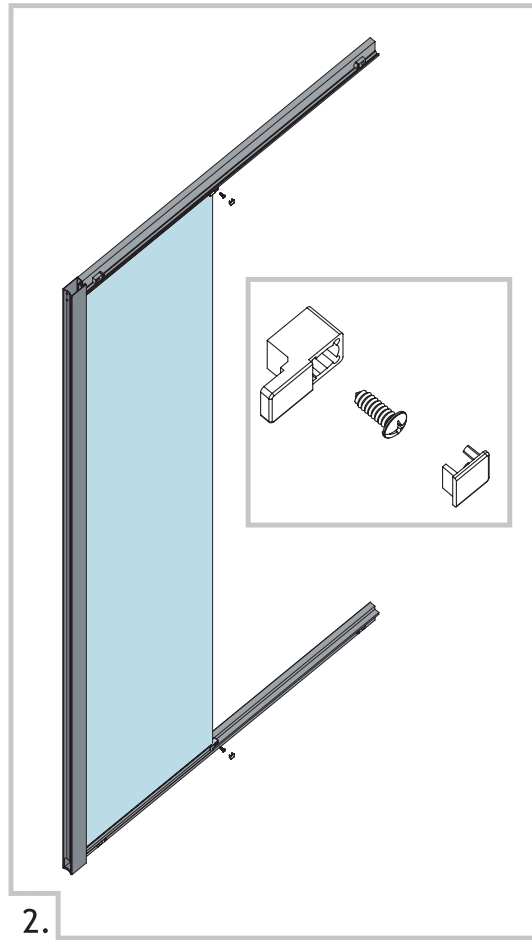
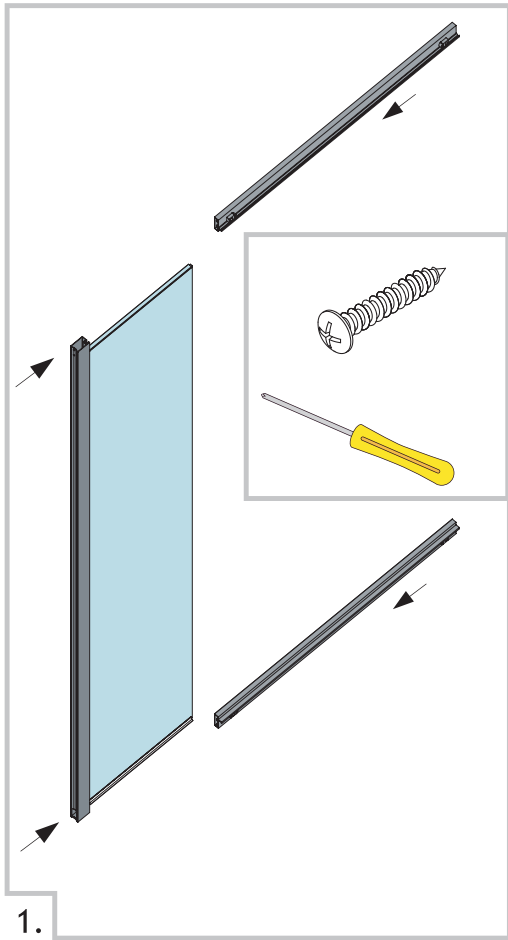

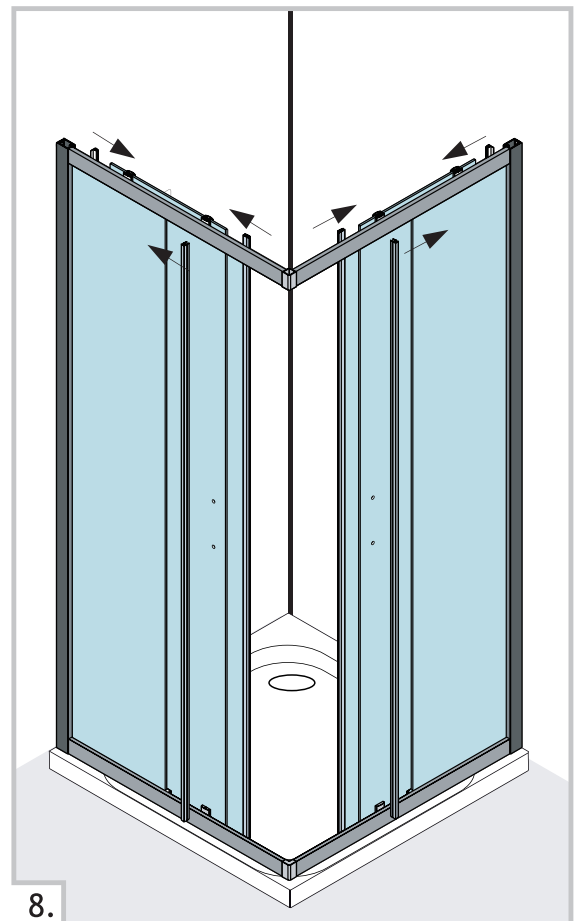
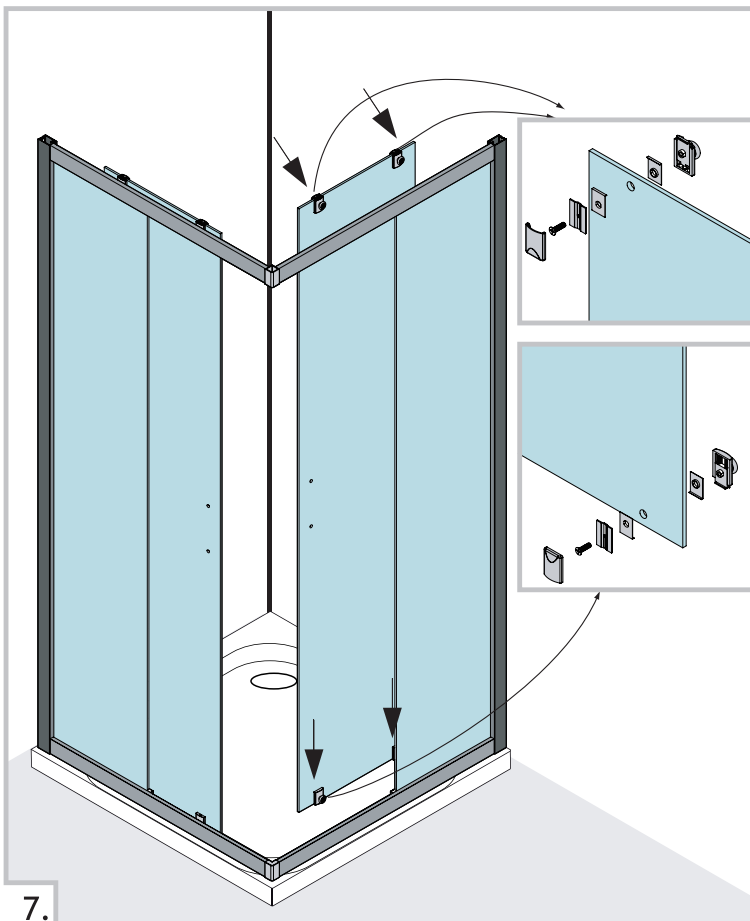
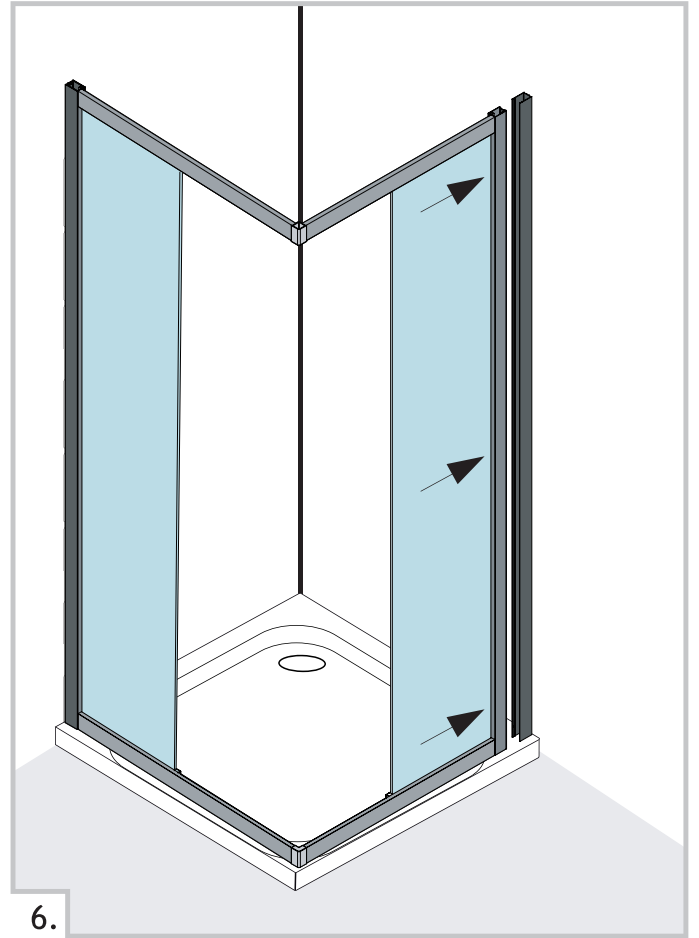
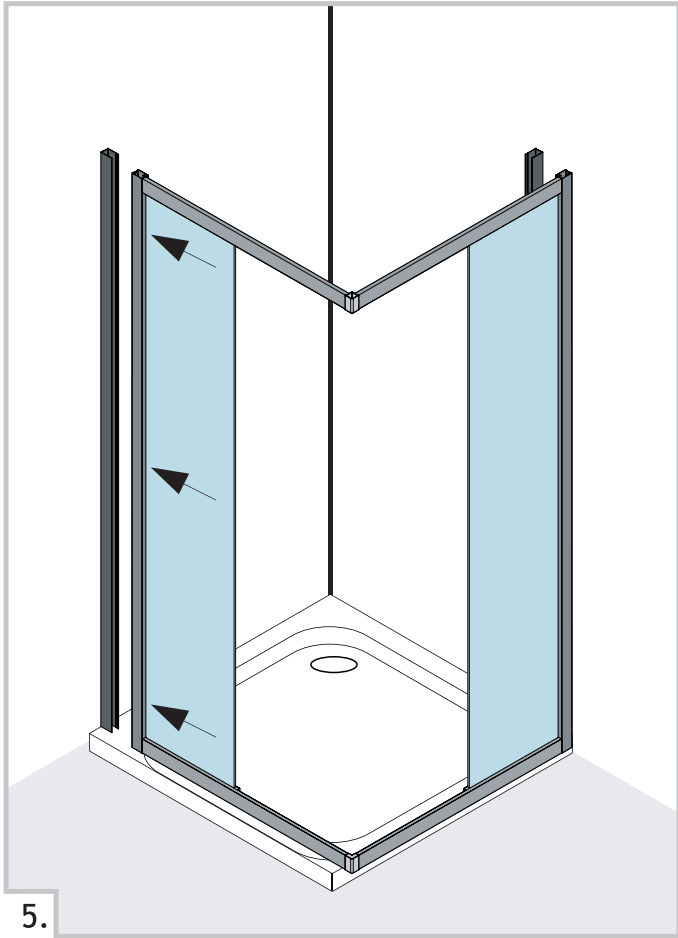

X-100 SQ

