

www.mundilite.com

Apdo. de Correos 72

C/ Malvasia Parc. 9 y 11 - Polígono Industrial Pino Blay - 46380 Cheste - Valencia - Spain

Telfs +34 96 251 28 94 / +34 96 070 23 81 - Fax: +34 96 251 14 78

email: admon@mundilite.com



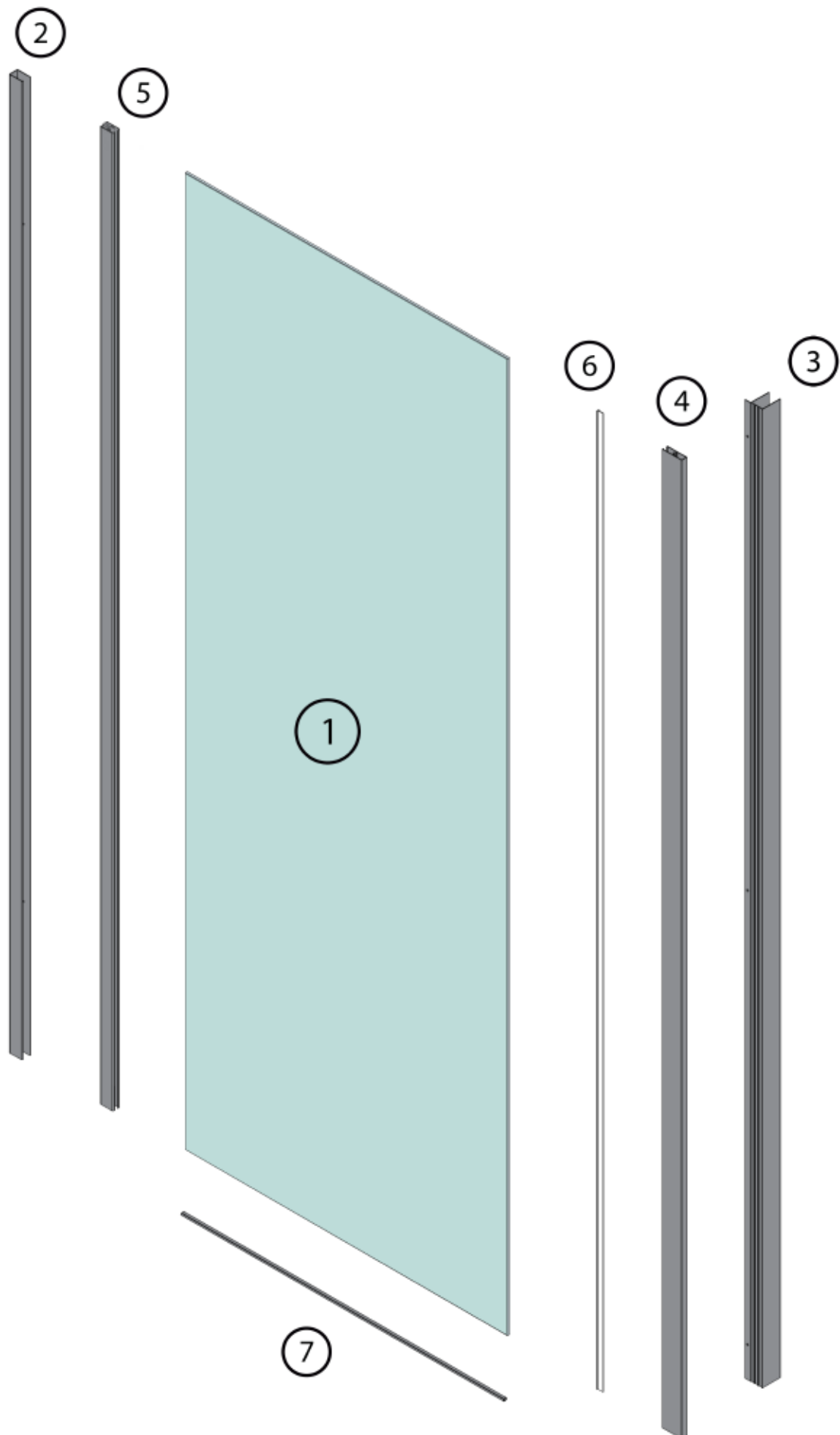

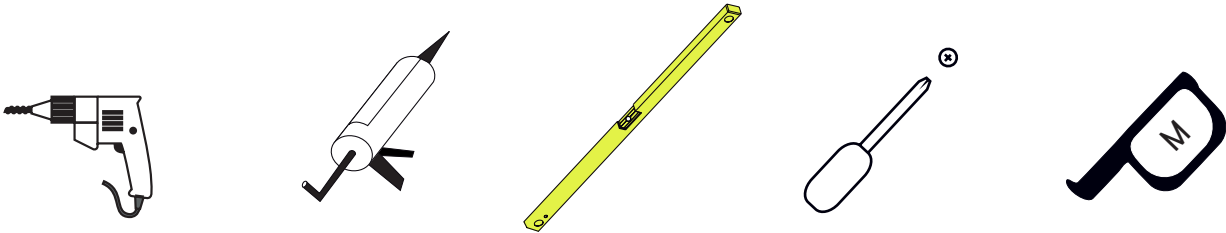

X-FIJO A MEDIDA

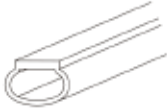
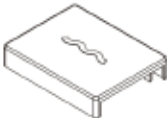

Herramientas / Tools / Outils / Strumenti di costruzione



Equipamiento / Features / Équipement / Capitolato

Ref.		Quant.
6.		1 Pc.
7.		1 Pc.
8.		1 Pc.
9.		1 Pc.
10.		1 Pc.
11.	 4x12	2 Pc.
12.		2 Pc.
13.		2 Pc.

X-FIJO A MEDIDA

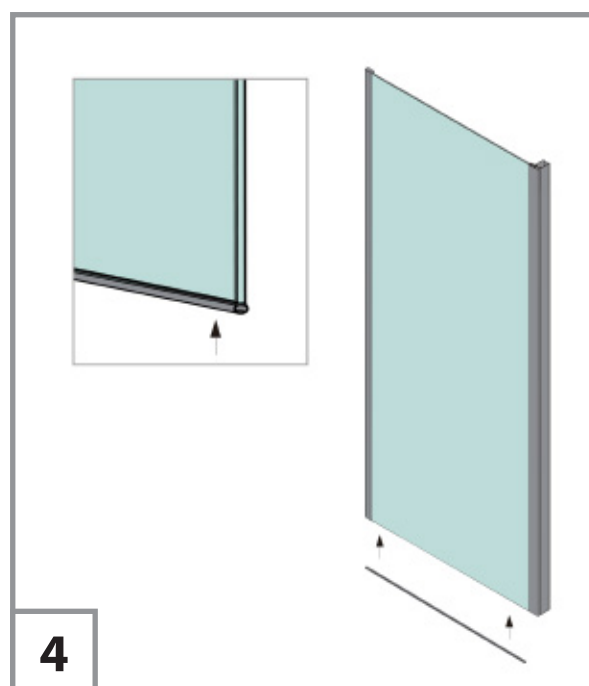
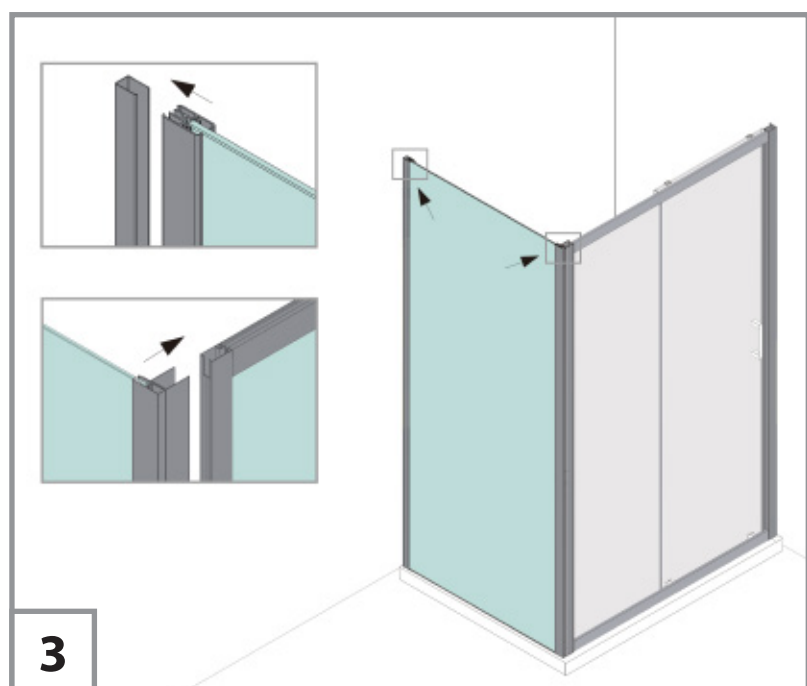
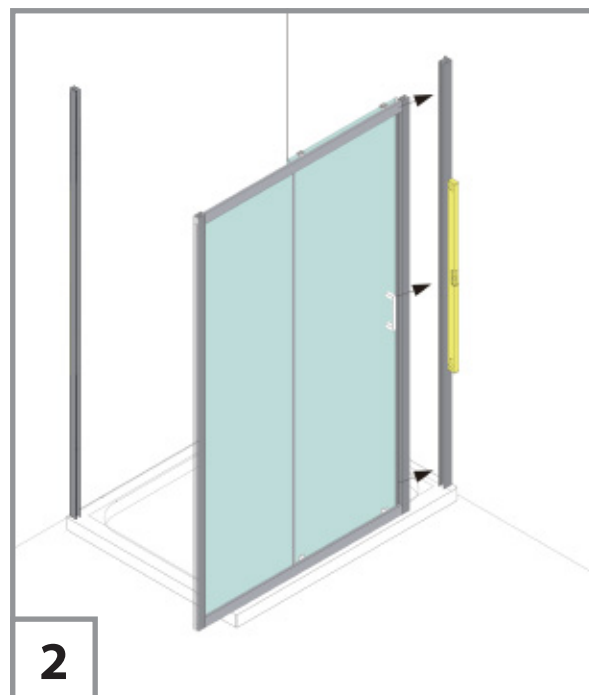
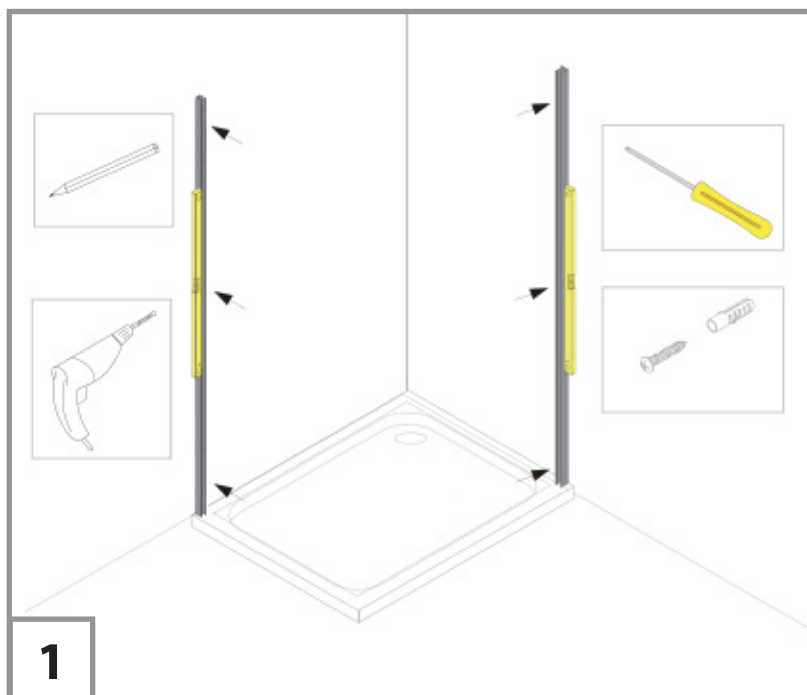

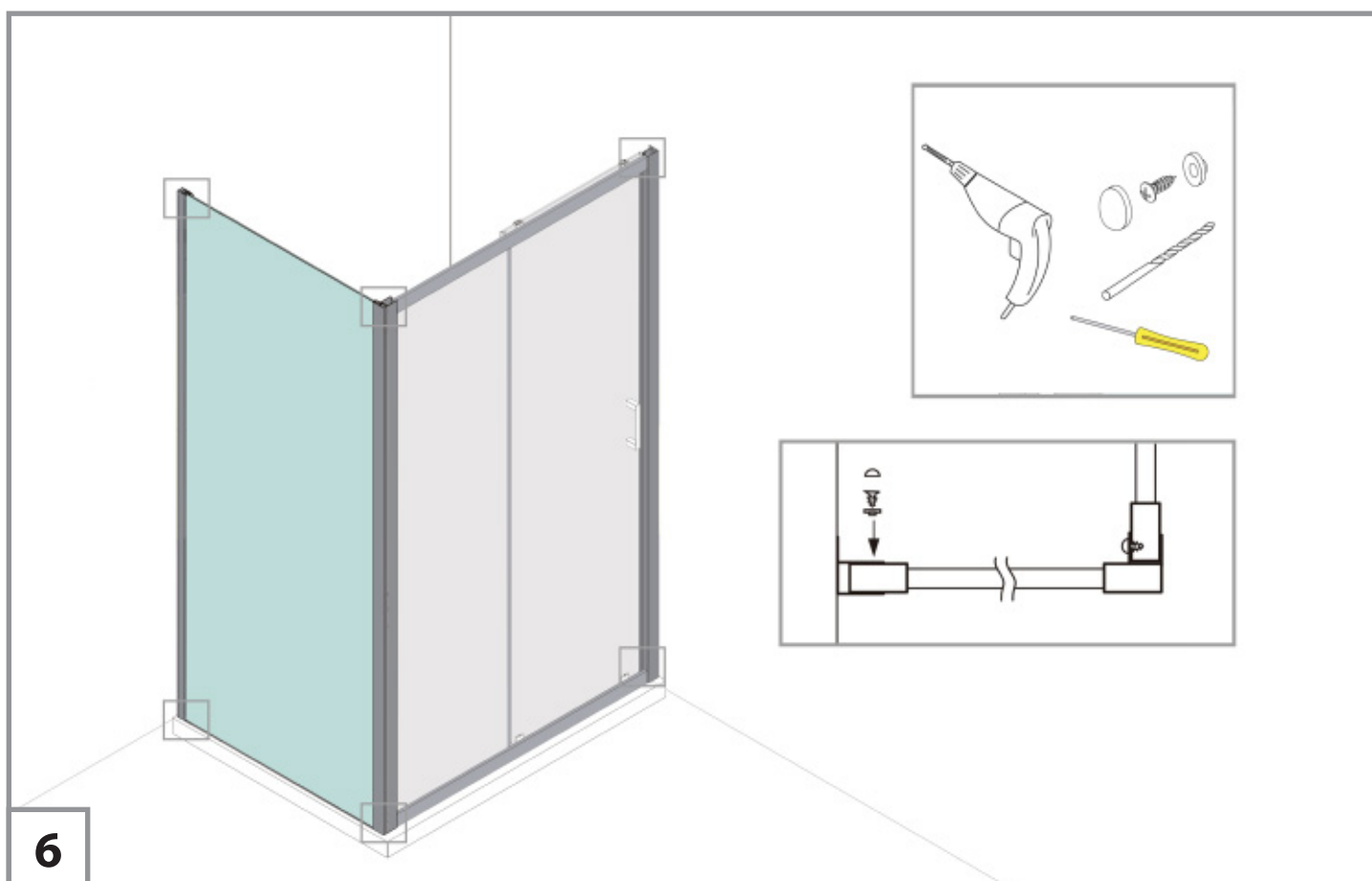
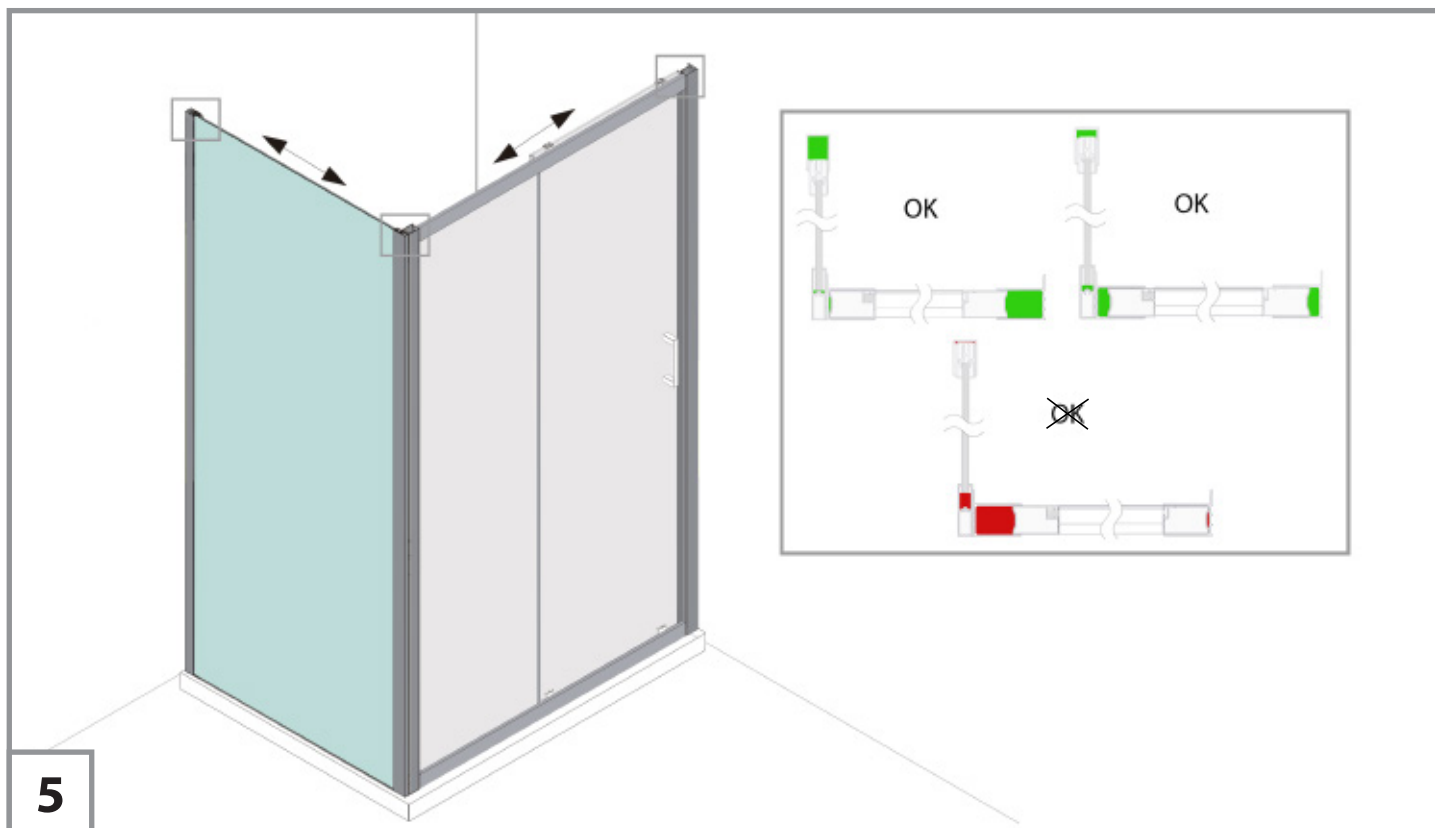

X-FIJO A MEDIDA

