



Tres fijos formando cabina.
Vidrio templado securizado 8 mm.
Juntas estanqueidad.
Sistema expansión corrector desnivel.
Tornillos fijación ocultos.
Barra estabilizadora.

Trois fixes formant la cabine
Verre trempé sécurisé 8 mm
Joints d'étanchéité
système d'expansion correcteur de dénivélé
Vis de fixation cachées
Barres stabilisatrices

3 panels forming a cabin.
8 mm toughened safety glass.
Water-proof door gasket.
Compensation profile.
Hidden fasteners screws.
Support bar.

Tre fissi a formare cabina
Vetro temperato di sicurezza 8 mm
Guarnizioni
Sistema espansione correttore dislivello
Viti fissaggio nascoste
Barra stabilizzatrice



Espesor del vidrio
Glass thickness
Verre épaisseur
Spessore del vetro

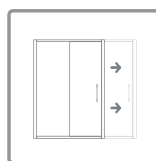

Ancho a medida
Custom width
Largeur personnalisée
Larghezza personalizzata

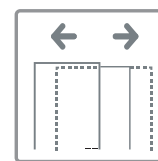

Sistema de expansión
Compensation profile
Système d'expansion
Sistema espansione



Juntas de estanqueidad
Water-proof door gasket
Joints d'étanchéité
Guarnizioni

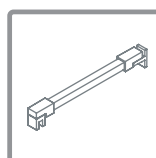

Barra estabilizadora
Support bar
Barres stabilisatrices
Barra stabilizzatrice

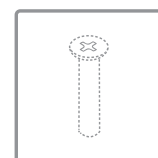

Tornillos ocultos
Hidden fixation screws
Vis de fixation cachées
Viti fissaggio nascoste



DIMENSIONES /
DIMENSIONS / DIMENSIONS / *DIMENSIONI*

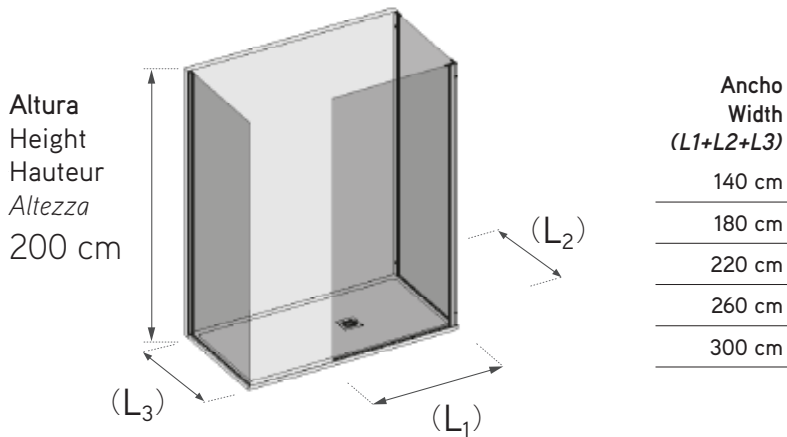

COMPLEMENTOS /
ACCESSORIES / ACCESSOIRES / *ACCESSORI*



Antical estándar
Easy clean glass standard
Anti-calcaire standard
Anticalcare standard

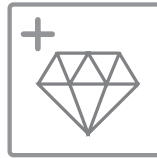

Power clean

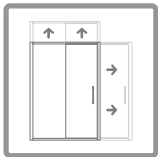

Altura y anchura especial
Special height and width
Hauteur et largeur spéciales
Altezza e larghezza speciali

ACABADOS /
FINISHES / FINITION / *FINITURA*

Blanco / Cromo & Silver:
Transparente
Carglass
Mate serigrafía

Blanc / Chrome & Silver:
Transparent
Carglass
Mat sérigraphie

White / Chrome & Silver:
Clear
Carglass
Frosted Decorated

Bianco / Cromo & Silver:
Transparent
Carglass
Opaco serigrafía