



Vidrio templado 6 mm.
Montado en línea, ángulo o sobre muro.
Montado en solitario.
Juntas de estanqueidad.
Sistema expansión corrector desnivel.
Barra estabilizadora.

Verre sécurisé 6 mm
Montage en alignement, en angle ou sur mur
Montage solitaire
Joints d'étanchéité
système d'expansion correcteur de dénivelé
Barres stabilisatrices

6 mm toughened safety glass.
Built in line, forming an angle or
extended panel.
Individually built.
Water-proof door gasket.
Compensation profile.
Support bar.

Vetro temperato di sicurezza 6 mm
Montato in linea, ad angolo o su parete
Montato individualmente
Guarnizioni
Sistema espansione correttore dislivello
Barra stabilizzatrice



Espesor del vidrio
Glass thickness
Verre épaisseur
Spessore del vetro

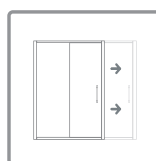

Ancho a medida
Custom width
Largeur personnalisée
Larghezza personalizzata

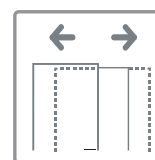

Sistema de expansión
Compensation profile
Système d'expansion
Sistema espansione



Juntas de estanqueidad
Water-proof door gasket
Joints d'étanchéité
Guarnizioni

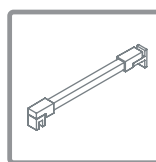

Barra estabilizadora
Support bar
Barres stabilisatrices
Barra stabilizzatrice



DIMENSIONES /
DIMENSIONS / DIMENSIONS / *DIMENSIONI*

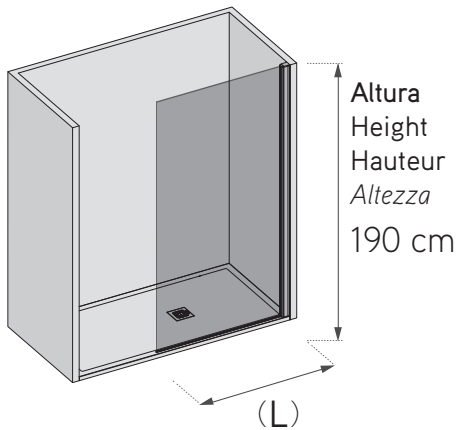

Ancho
Width
(L)

60 cm

80 cm

100 cm

COMPLEMENTOS /
ACCESSORIES / ACCESSOIRES / *ACCESSORI*



Antical estándar
Easy clean glass standard
Anti-calcaire standard
Anticalcare standard

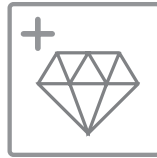

Power clean

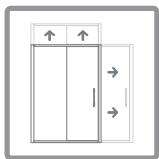

Altura y anchura especial
Special height and width
Hauteur et largeur spéciales
Altezza e larghezza speciali

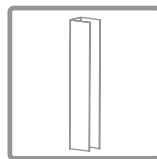

Perfil pergamón, blanco, cromo o silver.
Pergamon, white, chrome o silver profile
Profil pergamon, blanc, chrome o silver
Profili pergamon, bianco, cromo o silver

ACABADOS /
FINISHES / FINITION / *FINITURA*

Blanco / Cromo & Silver:
Transparente
Carglass
Mate serigrafía

Blanc / Chrome & Silver:
Transparent
Carglass
Mat sérigraphie

White / Chrome & Silver:
Clear
Carglass
Frosted Decorated

Bianco / Cromo & Silver:
Transparent
Carglass
Opaco serigrafía