



Dos hojas correderas con dos fijos en el mismo plano.  
Vidrio templado securizado 6 mm.  
Sin perfiles centrales.  
Pomos de diseño exclusivo.  
Cierre magnético enfundado.  
Juntas estanqueidad. Sistema guía doble.  
Doble rodamiento pista rodadura inox.  
Doble pinza metálica alto modulo de sujeción.  
Sistema expansión corrector desnivel.

Deux portes coulissantes avec deux fixes sur le même plan  
Verre sécurisé 6 mm ou acrylique  
Sans profil central  
Bouton de design exclusif  
Fermeture avec aimant dans soufflet  
Joints d'étanchéité  
Système de guide double  
Double pince métallique haut module de fixation  
Système d'expansion correcteur de dénivelé

Sliding double doors with double lateral panels.  
6 mm toughened safety glass.  
No central profiles.  
Exclusive knobs design.  
Coated magnetic clasp.  
Water-proof door gasket.  
Double running guide.  
Double rolling system (stainless steel).  
Double high module metallic clamp.  
Compensation profile.

*Due ante scorrevoli con due fissi sullo stesso piano*  
*Vetro temperato di sicurezza 6 mm*  
*Senza profili centrali*  
*Pomelli dal design esclusivo*  
*Chiusura magnetica inguainata*  
*Guarnizioni*  
*Sistema guida doppia*  
*Doppio cuscinetto guida di scorrimento inox*  
*Doppia pinza metallica alto modulo di fissaggio*  
*Sistema espansione correttore dislivello*

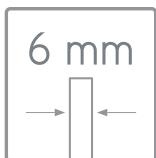

**Espesor del vidrio**  
Glass thickness  
Verre épaisseur  
Spessore del vetro



**Ancho a medida**  
Custom width  
Largeur personnalisée  
Larghezza personalizzata

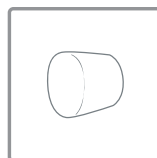

**Pomo de serie**  
Exclusive knobs design  
Bouton de design exclusif  
Pomelli dal design esclusivo

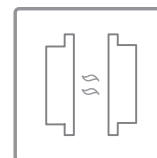

**Cierre magnético**  
Coated magnetic clasp  
Fermeture avec aimant  
Chiusura magnetica



**Rodamientos inox.**  
Stainless steel wheel  
Roulements inox  
Cuscinetti inossidabili



**Juntas de estanqueidad**  
Water-proof door gasket  
Joints d'étanchéité  
Guarnizioni

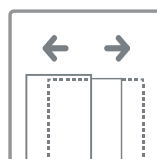

**Sistema de expansión**  
Compensation profile  
Système d'expansion  
Sistema espansione



**DIMENSIONES /**  
DIMENSIONS / DIMENSIONS / DIMENSIONI

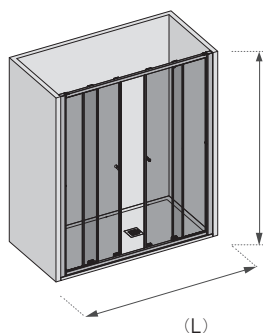

Altura  
Height  
Hauteur  
Altezza  
190 cm

Ancho Width Largeur Larghezza (L)
140 cm
160 cm
180 cm
200 cm

Para medida de 100 cm, apertura de 37 cm  
For 100 cm shower screen, a 37 cm opening  
Pour mesures de 100 cm, Ouverture de 37 cm  
Per dimensioni di 100 cm, apertura di 37 cm

**FIJO ESTÁNDAR DUCHA / SHOWER / DOUCHE / DOCCIA**

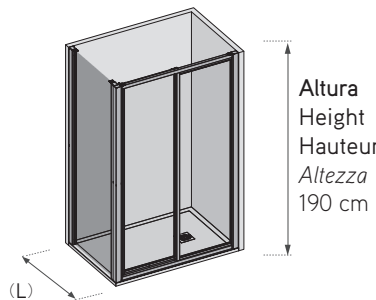

Altura  
Height  
Hauteur  
Altezza  
190 cm

Ancho Width Largeur Larghezza (L)
50 cm
70 cm
90 cm
120 cm

**COMPLEMENTOS /**  
ACCESSORIES / ACCESSOIRES / ACCESSORI

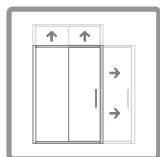

Altura y anchura especial  
Special height and width  
Hauteur et largeur spéciales  
Altezza e larghezza speciali



Power clean



Antical estándar  
Easy clean glass standard  
Anti-calcaire standard  
Anticalcare standard



Asa inox.  
Stainless steel handle  
Poignée inox.  
Maniglia inox.

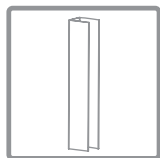

Perfil pergamón, blanco, cromo o silver.  
Pergamon, white, chrome o silver profile  
Profil pergamon, blanc, chrome o silver  
Profili pergamon, bianco, cromo o silver

**ACABADOS /**  
FINISHES / FINITION / FINITURA

**Blanco / Cromo & Silver:**  
Transparente  
Carglass  
Mate serigrafía

**Blanc / Chrome & Silver:**  
Transparent  
Carglass  
Mat sérigraphie

**White / Chrome & Silver:**  
Clear  
Carglass  
Frosted Decorated

**Bianco / Cromo & Silver:**  
Transparent  
Carglass  
Opaco serigrafia