

# Fijo Smart

Instrucciones de instalación  
*Assembly instructions*  
Instructions de montage  
*Prescrizioni di montaggio*

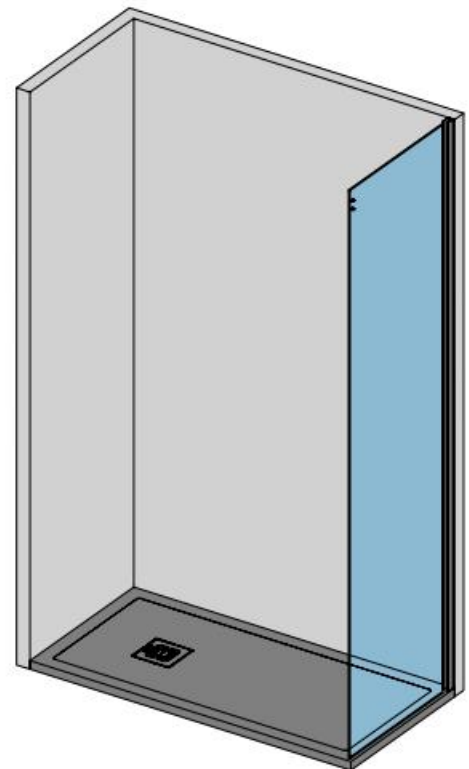
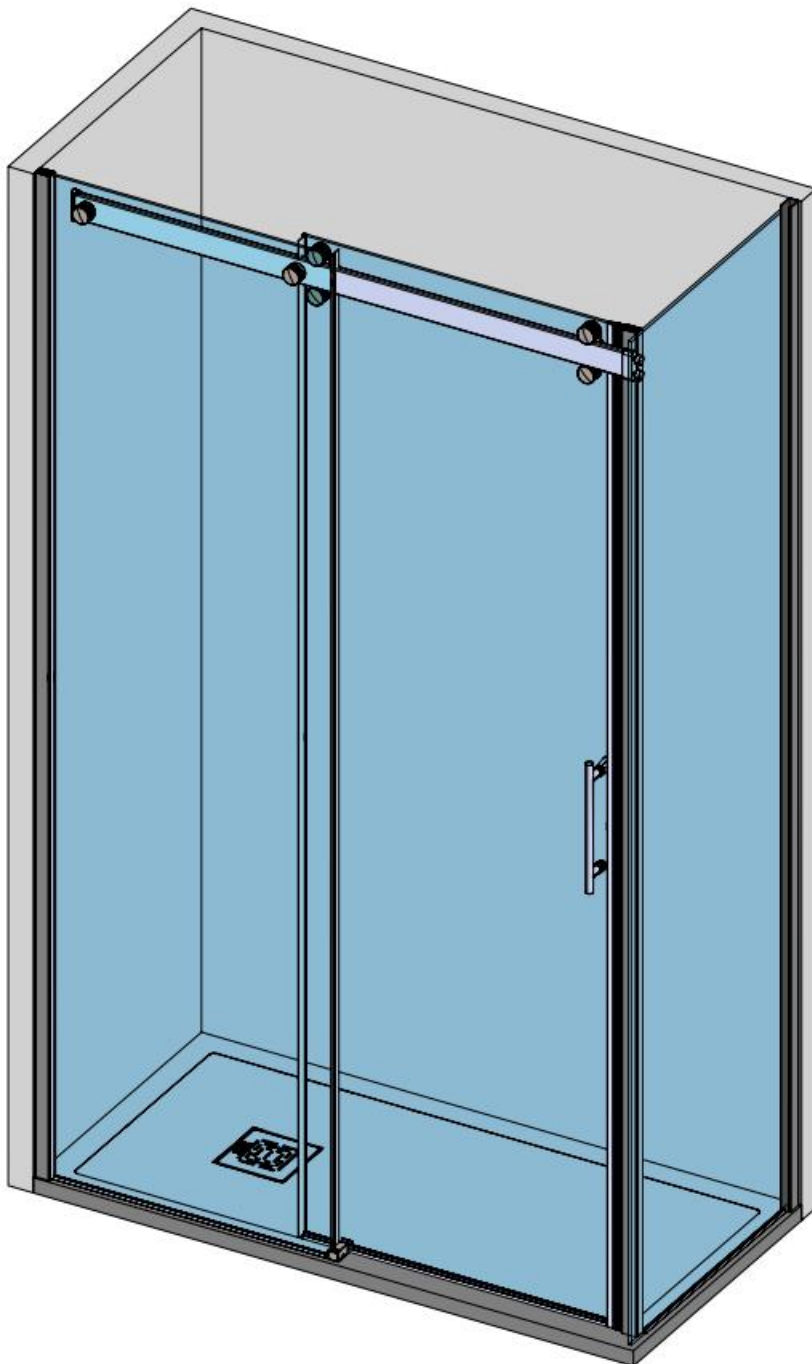

C/ Malvasia Parc. 9 y 11 - Polígono Industrial Pino Blay - 46380 Cheste - Valencia - Spain

Telfs +34 96 251 28 94 / +34 96 070 23 81 - Fax: +34 96 251 14 78

email: [admon@mundilite.com](mailto:admon@mundilite.com)

[www.mundilite.com](http://www.mundilite.com)



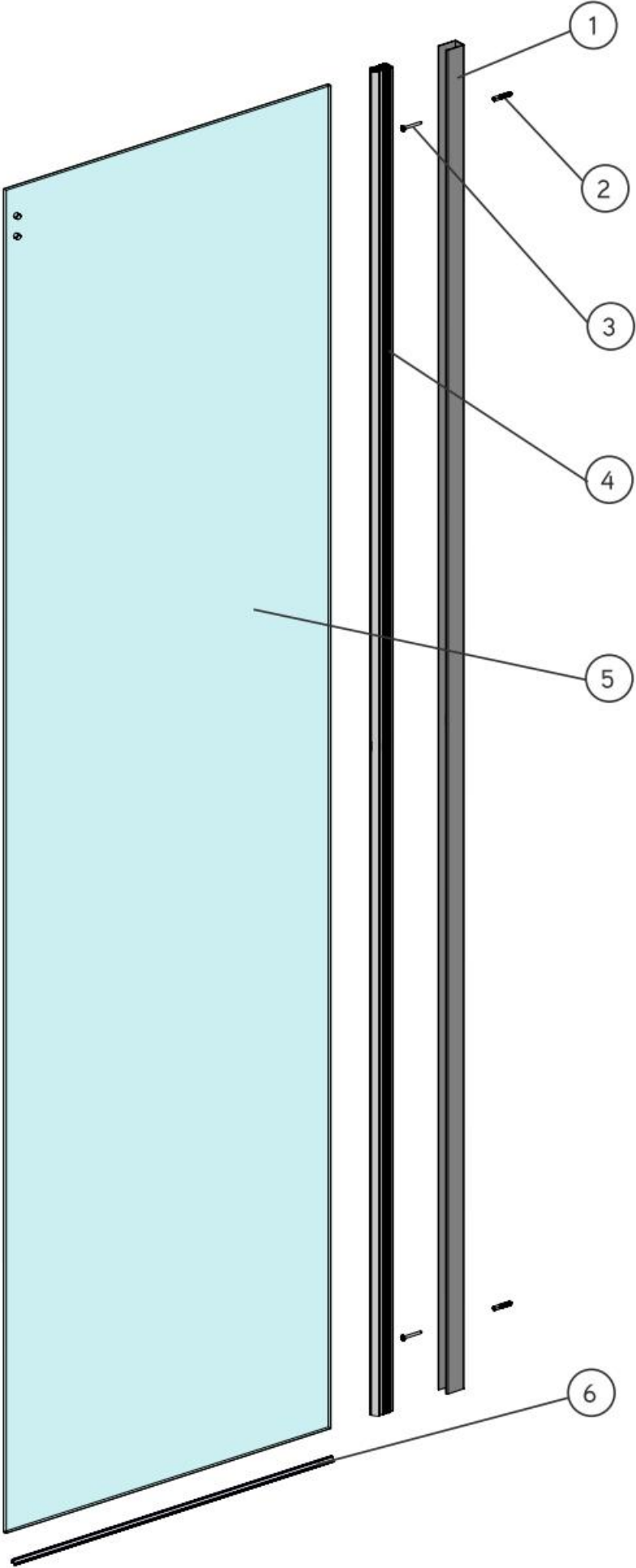

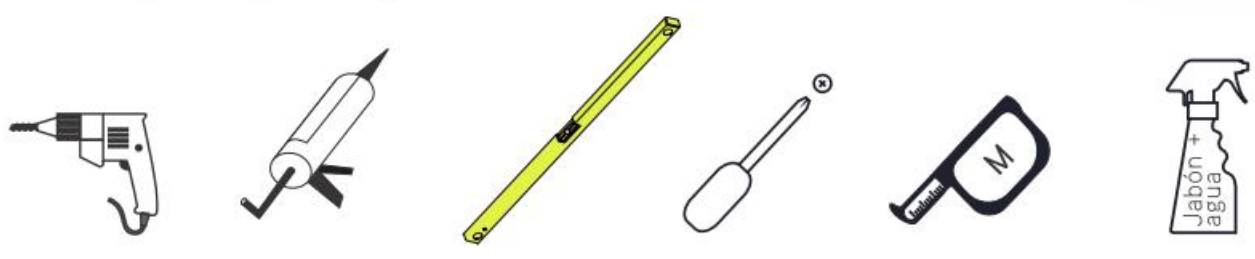

  
mundilite



Herramientas / Tools / Outils / Strumenti di costruzione

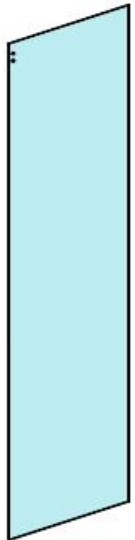

Equipamiento / Features / Équipement / Capitolato

Ref.		Quant.
1.		1 Pc.
2.		2 Pc.
3.		2 Pc.
4.		1 Pc.
5.		1 Pc.
6.		1 Pc.

# Fijo Smart

