

Fijo Estandar

Instrucciones de instalación
Assembly instructions
Instructions de montage
Prescrizioni di montaggio

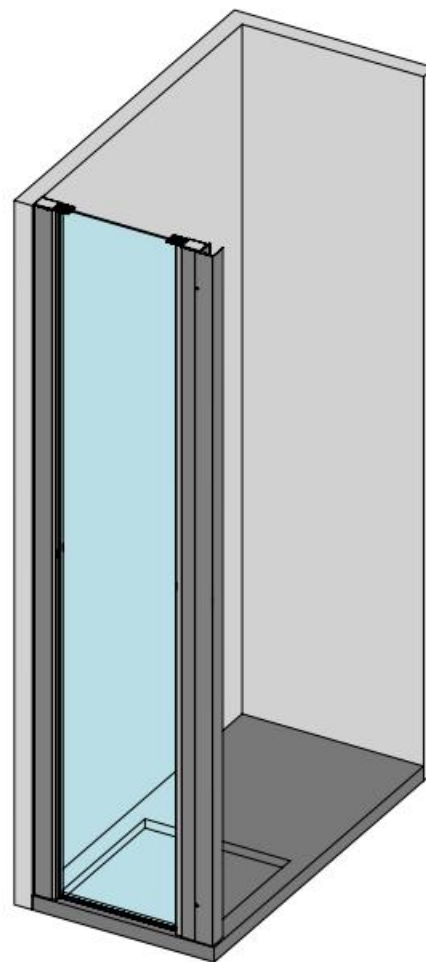
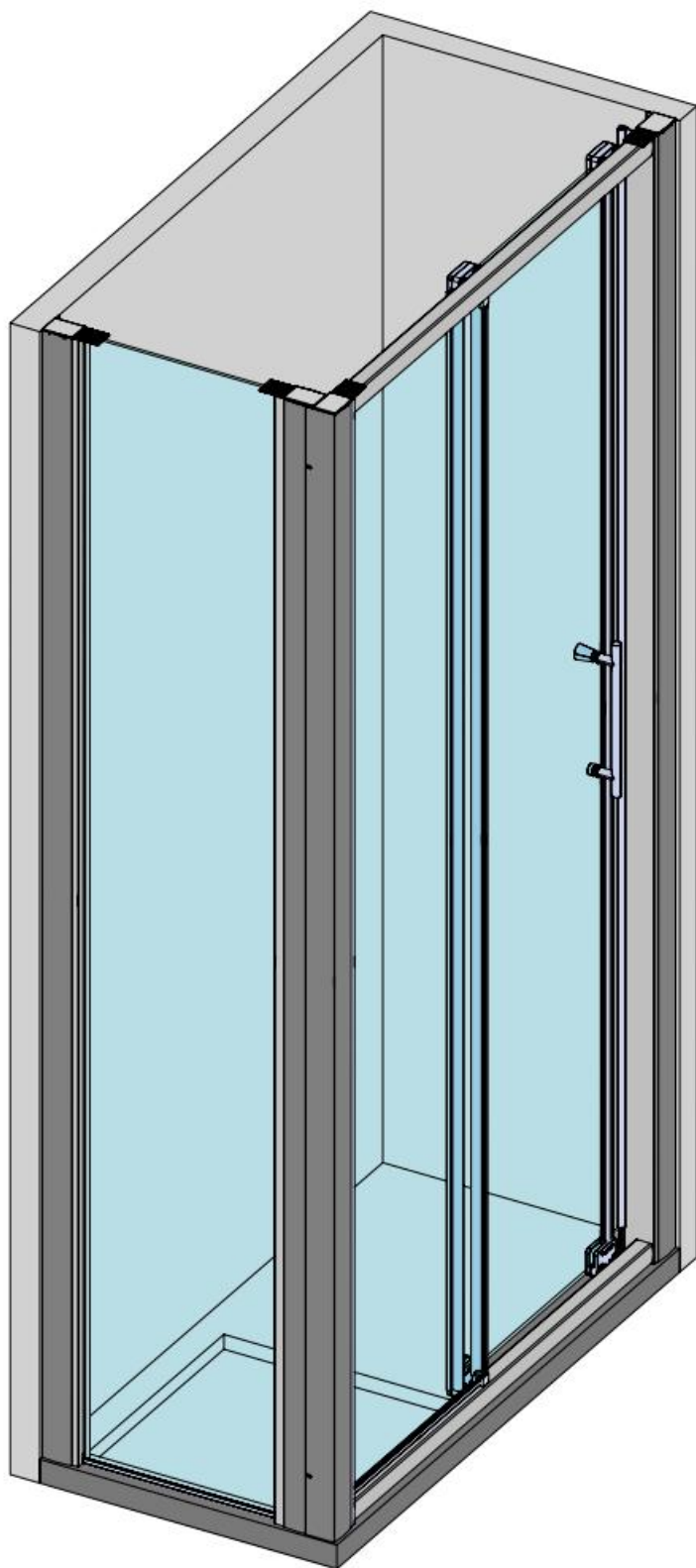

www.mundilite.com

Apdo. de Correos 72

C/ Malvasia Parc. 9 y 11 - Polígono Industrial Pino Blay - 46380 Cheste - Valencia - Spain

Telfs +34 96 251 28 94 / +34 96 070 23 81 - Fax: +34 96 251 14 78

email: admon@mundilite.com





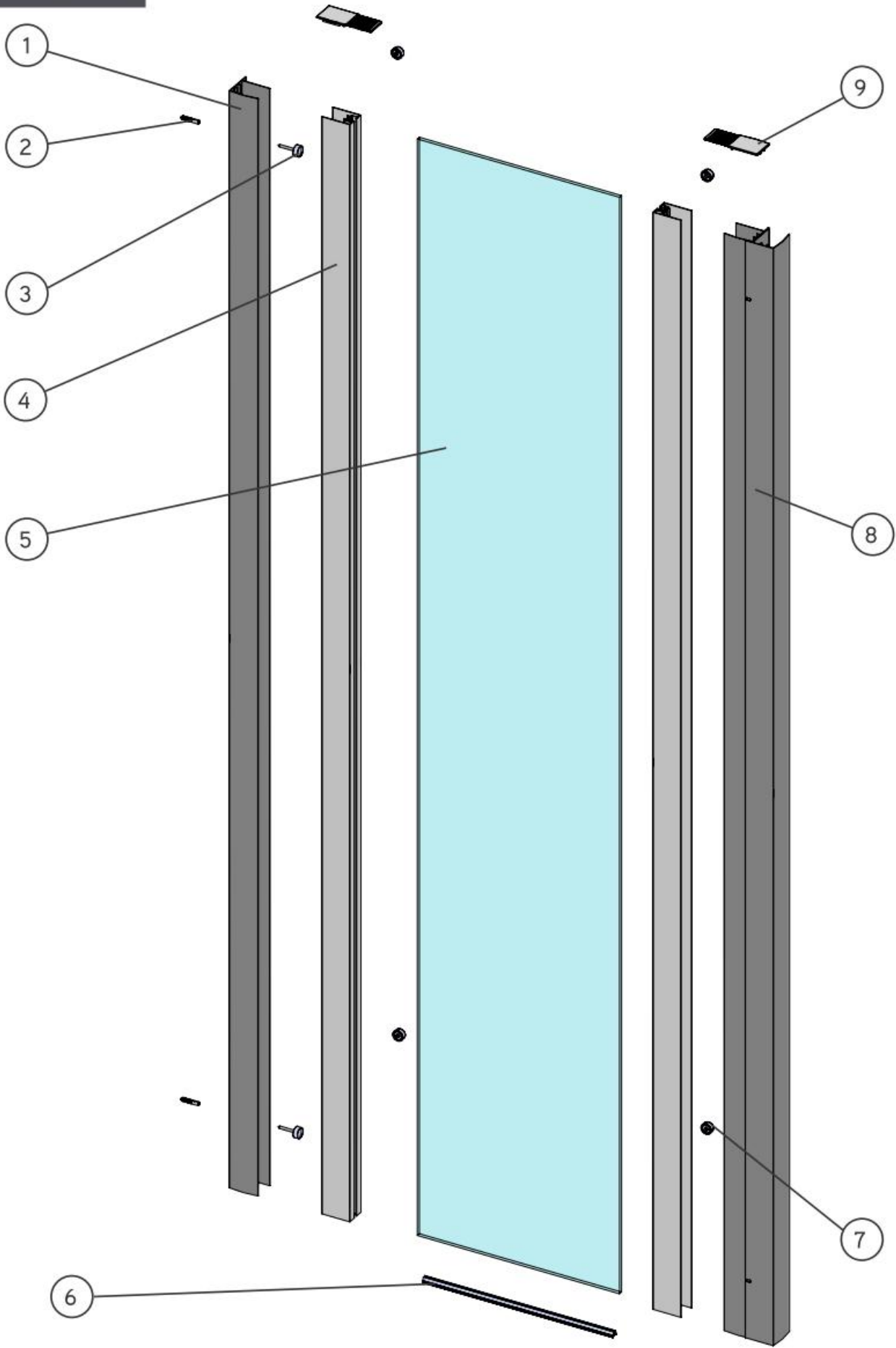

mundilite

Fijo Estandar

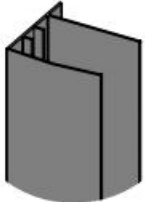

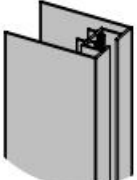

Equipamiento / Features / Équipement / Capitolato

| Ref. | | Quant. |
|------|---|--------|
| 1. |  | 1 Pc. |
| 2. |  | 2 Pc. |
| 3. |  | 2 Pc. |
| 4. |  | 2 Pc. |
| 5. |  | 1 Pc. |
| 6. |  | 1 Pc. |

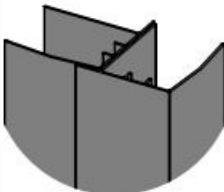
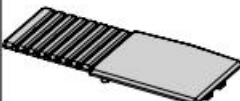
| Ref. | | Quant. |
|------|--|--------|
| 7. |  | 4 Pc. |
| 8. |  | 1 Pc. |
| 9. |  | 2 Pc. |

Fijo Estandar

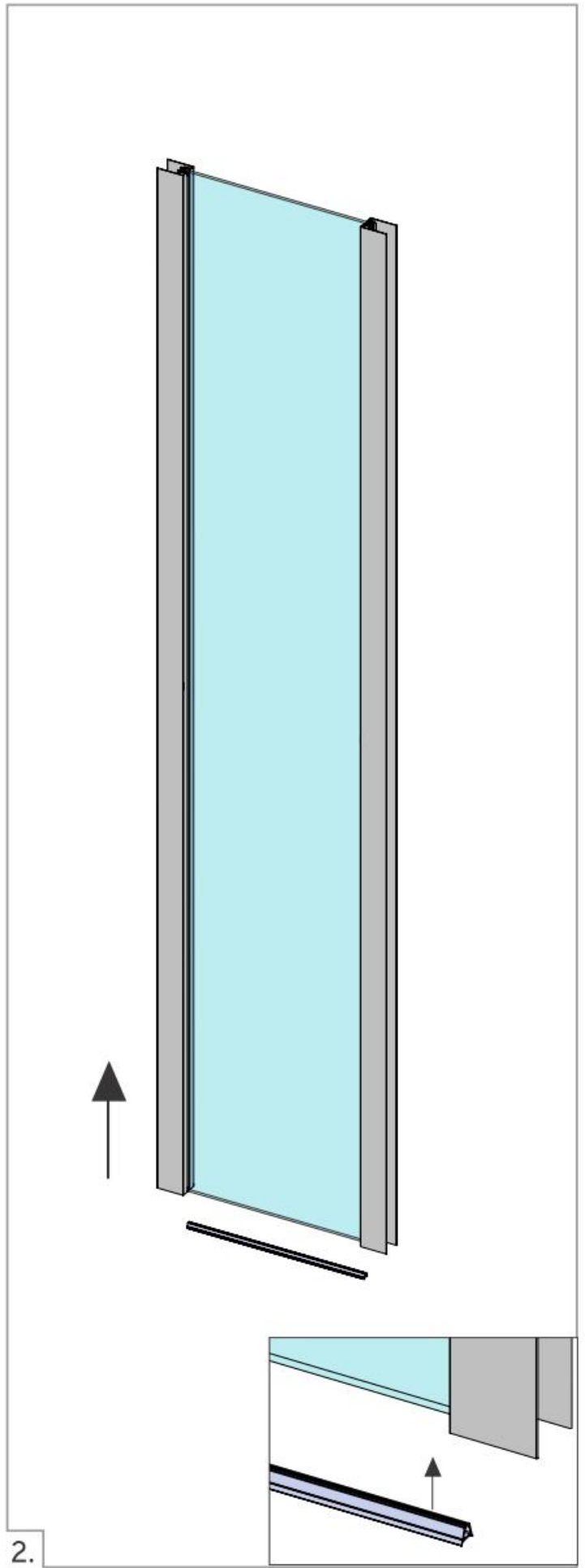
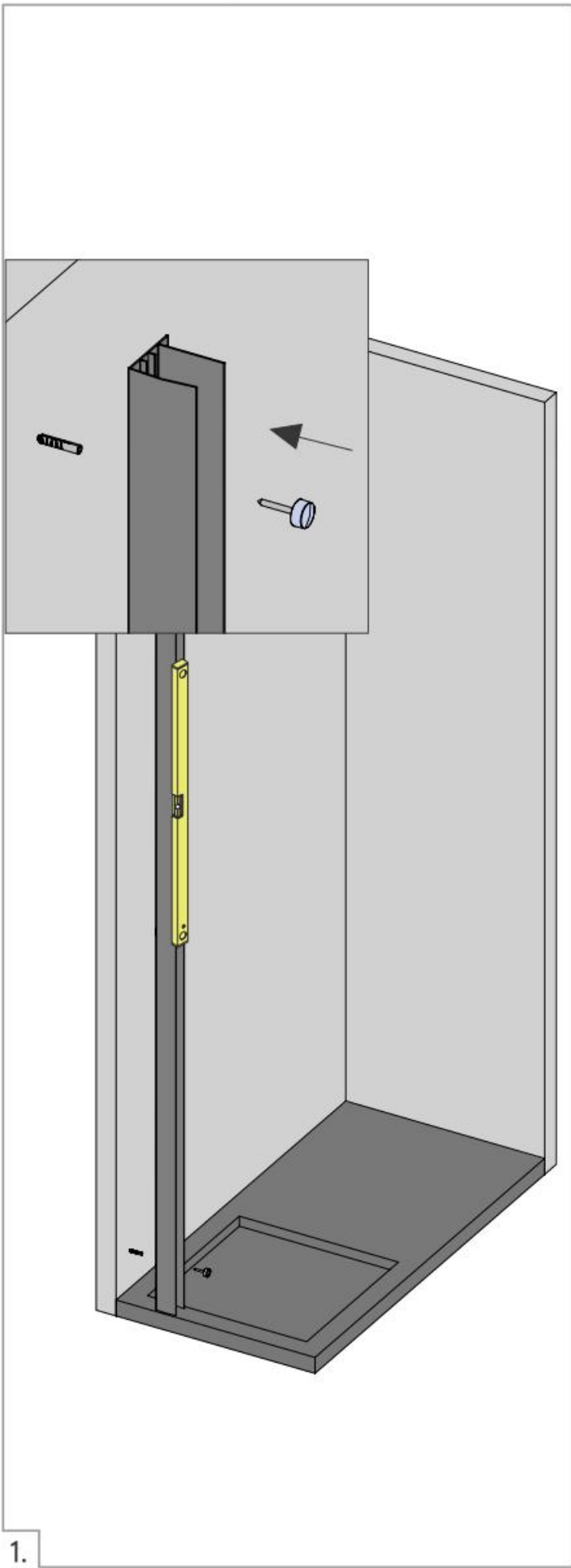

Fijo Estandar

