

SHOWER TRAYS

PLATOS
DE DUCHA

Tarifa - Catálogo / *Price List - Catalogue*

PLATOS DE DUCHA
SHOWER TRAYS



TARIFA - PRICE LIST



TU PROVEEDOR
DE BIENESTAR Y
SOLUCIONES A MEDIDA

*YOUR PROVIDER
OF COMFORT AND
CUSTOMISED SOLUTIONS*



¿Buscas un **baño de calidad** con un elevado nivel estético y funcional? En Mundilite somos especialistas en la **fabricación de productos para baños con diseño y funcionalidad**.

Somos un proveedor de confianza, con el que te sentirás a gusto durante todo el proceso y satisfecho al comprobar el resultado. Ahora bien, ¿qué nos diferencia? ¿por qué somos capaces de garantizar ese nivel de satisfacción? ¿qué nos permite fidelizar a clientes como tú, que buscan la mejor opción para su vivienda o centro de trabajo?

*Are you looking for a **quality bathroom** with a great aesthetic and functionality? At Mundilite, we are specialists in the **manufacture of bathroom products with design and functionality**.*

We're a reliable supplier, with whom you'll feel at ease throughout the process and satisfied when seeing the result. But what makes us different? Why are we able to guarantee this level of satisfaction? What allows us to retain customers like you, who are looking for the best option for their home or workplace?



Queremos explicarte cuáles son los atributos diferenciales que te proporcionará el trabajar con Mundilite. Son, sin lugar a dudas, los aspectos que más valoran nuestros clientes.

We want to explain the differential attributes provided by working with Mundilite. Without a doubt, these are the aspects that our customers value the most.

Experiencia innovadora

La experiencia es un grado, sobre todo en el desempeño de la actividad y los trabajos técnicos. Llevamos **más de 25 años apostando por la innovación** en este sector, lo que nos ha permitido aprender mucho y anticiparnos al futuro para garantizar un presente extraordinario.

Innovative experience

*Experience counts, especially when carrying out job activities and technical work. We've spent **more than 25 years backing innovation** in this sector, which has allowed us to learn a lot and anticipate the future to ensure an extraordinary present.*

Creatividad y diseño

Ya te hemos hablado de la innovación como rasgo incuestionable de nuestra marca. Así, contamos con distintos **modelos de utilidad y patentes a nivel europeo** que nos permiten acercarte nuevas soluciones mucho más personalizadas. Estamos especializados como **profesionales del sector**, canal contract y canal hotelero. Invertimos permanentemente en I+D+i para mantener siempre el ritmo tecnológico del momento.

Creativity and design

*We've already talked about innovation as an undeniable characteristic of our brand. Thus, we have different **utility models and patents at a European level** which allow us to bring you new solutions which are much more personalised. We are specialised **in sector professionals**, the contract channel and hotel channel. We constantly invest in R+D+i to always keep up with the technological pace of the moment.*



Seriedad y solvencia

Cumplimos nuestros compromisos. Somos absolutamente fiables, estamos plenamente consolidados en el sector y jamás creamos falsas expectativas ni incumplimos las de nuestros clientes. Si te decimos que el trabajo estará terminado en unas condiciones y plazos definidos, así es como lo tendrás.

Tecnología humanizada

Apostamos por las tecnologías de última generación. Por ello, **disponemos de cadcam**, ingeniería de producto, especialización en termoestables y muchos más avances técnicos. Ahora bien, somos conscientes de que la principal diferencia radica en las personas. Es por eso que contamos con los mejores y más cualificados profesionales, **capaces de poner a tu servicio los nuevos avances disponibles.**

Confianza

Te hablamos claro, te asesoramos y te ayudamos a adecuar tu proyecto. Cumplimos nuestras promesas, no te fallaremos. Somos capaces de personalizar tu espacio y te ofrecemos soluciones a medida que **desarrollamos codo con codo junto a ti.** Porque cada espacio es único y te mereces lo mejor: una solución global personalizada tan funcional como bella.

Amplitud de gama

Nuestro catálogo incluye **multitud de productos y referencias** de todo tipo, especialmente platos de ducha, mamparas, fregaderos, lavabos, muebles de baño, paneles 3D y otros artículos semejantes. De este modo, puedes elegir con gran libertad según tus inclinaciones estéticas.

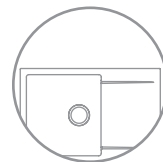
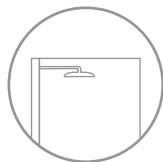

Seriousness and trustworthiness

***We meet our commitments.** We are absolutely reliable, fully established in the sector and never create false expectations or fail to meet those of our customers. If we tell you that the work will be finished under certain conditions and deadlines, this is how it will be.*

Humanised technology

*Of course, we are committed to the latest technologies. That is why **we have cadcam**, product engineering, specialisation in thermosets and many more technical advances. Now, we're aware that the main difference lies in people. That's why we have the best and most qualified professionals, **capable of really putting these new advances available at your service.***

Trust

*We speak to you clearly, advise you and help you to customise your project. We keep our promises, we won't let you down. We're able to personalise your space and offer you customised solutions which **we develop side by side with you.** Because each space is unique and you deserve the best: a customised global solution which is as functional as it is beautiful.*

Extensive range

*Our catalogue includes a **multitude of products and references** of all kinds, especially shower trays, shower screens, kitchen and bathroom sinks, bathroom furniture, 3D panels and other similar items. In this way, you can choose freely, according to your aesthetic inclinations.*

Ahora que sabes qué hacemos y cómo trabajamos, ¿por qué no contactas con nosotros? **Llámanos sin compromiso:** escucharemos lo que necesitas y te ofreceremos una propuesta personalizada que te encantará.

*Now that you know what we do and how we work, why don't you get in touch with us? **Call us without obligation:** we'll listen to what you need and offer you a personalised proposal that you'll love.*

ÍNDICE / INDEX





ST-ONE 6

Complementos / <i>Accessories</i>	12
Acabados / <i>Finishes</i>	14
Sin límites / <i>Without limits</i>	18



VENICE ^{NEW}	20
-----------------------	----



SERIE UNIC ^{NEW}	24
---------------------------	----

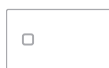

LISO	30
------	----



KORE	36
------	----



ENMARCADO	40
-----------	----



XXL	44
-----	----



BIZONA	48
--------	----



NEO	52
-----	----



ZONA DE SECADO	56
----------------	----



ANGULARES	60
-----------	----

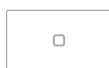

PANELES PUR / <i>Pur panels</i>	68
---------------------------------	----

RAMPA / <i>Access ramp</i>	
----------------------------	--

ZÓCALO / <i>Elevated edging</i>	70
---------------------------------	----

EXPOSITOR/ <i>Display stand</i>	72
---------------------------------	----

SERIE
ST-ONE





SERIE ST-ONE

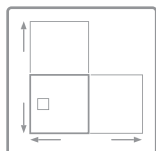

Fabricación a medida
Made to measure



Planimetría perimetral para
el asiento de la mampara
Flat perimeter for the shower door



Pigmentación en masa
Mass pigmentation

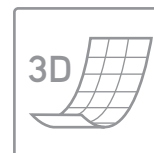

Curva de desagüe tridimensional
Three-dimensional drainage curve

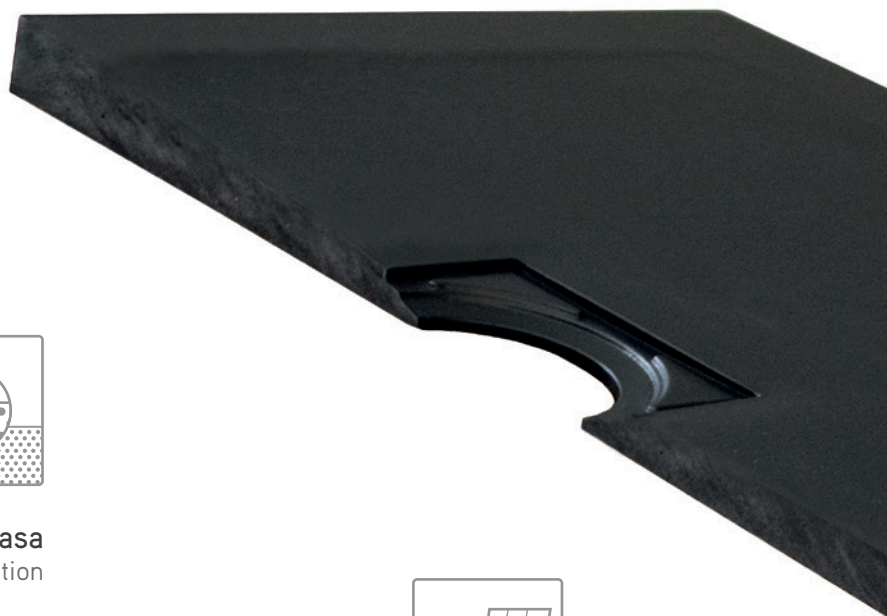

8

La serie de platos **ST-ONE** presenta una gama de productos actual, diseñada tecnológicamente para la total evacuación del agua.

El recubrimiento HIGH TECH, dotado con propiedades antideslizantes y antibacterianas, ofrece una máxima seguridad y confort. Además disponemos, a petición de técnicos y de nuestros clientes, un estudio de antideslizamiento que cumple con la normativa más exigente.

Gracias a la variedad de texturas y colores, combina diseño y calidad permitiendo crear un estilo personal.

*The **ST-ONE** shower tray series presents a range of modern products technically designed for complete water drainage.*

The HIGH TECH coating with non-slip, antibacteria finish offers maximum comfort and safety. On request of technicians and our clients we have a study of the non-slip qualities, complying with the highest current regulations.

With the variety of textures and colours, the ST-ONE series combines design and quality for a unique personal style.



Antibacteriano
Antibacteria finish



Antideslizamiento clase 3
Non-slip, class 3



Superficie hidrófoba
Water repellent surface

9



Fácil reparación
Easy repair



Fácil limpieza
Easy clean



**Resistencia a productos de
limpieza domésticos**
Resistant to cleaning products



Planimetría perimetral para el asiento de la mampara
Flat perimeter for the shower door

Todos nuestros platos cuentan con una **superficie perimetral plana** que permite la **perfecta instalación** del revestimiento de las paredes así como de la mampara, sin antiestéticos cordones de relleno. Los cantos de nuestros platos están realizados a 90° con un **ángulo vivo** y el **menor radio posible**, de forma que cuando lo instalamos a filo pavimento la unión sea lo menos perceptible posible.

All our trays have a flat surface with perimeter that allows the perfect installation of the wall covering, as well as the screen, without unsightly filling cords. The edges of our trays are made at 90° with a sharp angle and the smallest possible radius, so that when we install it flush with the paving, the joint will be as imperceptible as possible.

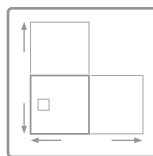

Fabricación a medida
Made to measure

Nuestros platos se realizan a medida **sin cortes ni añadidos**, sea cual sea tu proyecto. Realizamos cada plato como una **pieza única**, dotándolo de todas las características de los platos ST-ONE, con unos **tiempos de producción inferiores a la media** del mercado. Puedes elegir las medidas, diseños y acabados, sin renunciar a la mayor seguridad y confort.

Our trays are made-to-measure without cuts or additions, whatever your project is. We make each tray as a single piece, providing it with all the characteristics of ST-ONE trays, with production times lower than the market average. You can choose the measurements, designs and finishes, without giving up great safety and comfort.

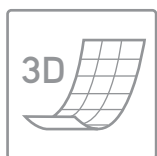

Curva desagüe tridimensional
Three-dimensional drainage curve

Las pendientes de nuestros platos están realizadas con curvas 3D, lo que supone un **desnivel del 60%** entre el borde y la zona de desagüe, permitiendo la **perfecta evacuación** de la totalidad de la superficie del plato. Esto nos permite también tener una altura de columna de agua de 17 mm optimizando los tiempos de evacuación.

The slopes of our trays are made with 3D curves, which means a 60% unevenness between the edge and the drainage area, allowing perfect drainage of the entire surface of the tray. This also allows us to have a water column height of 17 mm, optimising drainage times.



Antibacteriano
Anti-bacteria finish

Nuestro tratamiento antibacteriano **inhibe el crecimiento de hongos y bacterias**, una herramienta muy eficaz contra manchas y malos olores. Según el instituto JIS (Japanese Industrial Standard) y la normativa Z2801 referente al "Test for antimicrobial activity and efficacy" de 2006, nuestros productos cumplen dicha norma.

The antibacterial treatment inhibits the growth of fungi and bacteria, a very effective tool against stains and unpleasant odors. According to the institute JIS (Japanese Industrial Standard) and regulations Z2801 regarding the "Test for antimicrobial activity and efficacy" of 2006, our products comply with the standard.



Fácil reparación
Easy repair

Nuestra tecnología de HIGH TECH basado en poliuretánicos de alta calidad, permite una **fácil recuperación de la superficie**, sin necesidad de reparar todo el producto, tan solo la parte dañada.

Our HIGH TECH technology based on high quality polyurethane allows easy recovery of the surface, without the need to repair the entire product, only the damaged part.



Antideslizamiento clase 3
Non-slip, class 3

Según la norma UNE-EN 12633:2003 que nos permite determinar el valor de la resistencia al deslizamiento / resbalamiento, nuestros productos cumplen la Clase 3.

According to the regulation UNE-EN 12633:2003 which allows us to determine the value of the resistance to sliding / slipping, the products are Class 3.

PROPIEDADES ST-ONE / ST-ONE PROPERTIES



Resistencia a productos de limpieza domésticos

Resistant to cleaning products

Producto / Product	Exposición / Exposure time	Resultado / Result
LEJIA / Bleach	24H	Resiste / Resist
SALFUMAN / Hydrochloric acid	24H	Resiste / Resist
DON LIMPIO / Mr Proper	24H	Resiste / Resist
VIAKAL	24H	Resiste / Resist
VINAGRE / Vinegar	24H	Resiste / Resist
AMONIACO / Ammonia	24H	Resiste / Resist
KH-7	24H	Resiste / Resist
CILLIT BANG	1H	Resiste / Resist
LACA DE UÑAS OSCURA / Dark nail varnish	24H	Resiste / Resist
LACA DE UÑAS CLARA / Clear nail varnish	24H	Resiste / Resist
AGUA OXIGENADA / Hydrogen peroxide	24H	Resiste / Resist
BETADINE	24H	Resiste / Resist
VINO / Wine	24H	Resiste / Resist

* Tener especial cuidado con los tintes de pelo (dependiendo si es claro u oscuro, resiste a un tiempo de exposición de entre 5 a 30 minutos), y la acetona (puede alterar moderadamente el brillo y/o color tras 1 minuto de exposición).

* Be particularly careful with **hair dye colour** (depending on whether it is light or dark, resistance will vary between 5-30 minutes) and **acetone** (this product could alter moderately the gloss and color after 1 minute exposure).

INFORMACIÓN / INFORMATION

ATENCIÓN. En el montaje del plato asegurarse de dejar espacio suficiente, tanto de ancho como de alto, para que la válvula no tenga contacto con el suelo.

ATTENTION. Please, during the shower tray installation be sure there is enough space for the valve, both in the width and in the height. The valve must not rest on the ground.

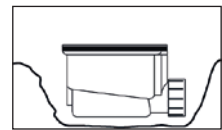

VÁLVULAS ST-ONE / ST-ONE DRAINERS

Válvula Estándar Standard Drainer

ref. VSTD

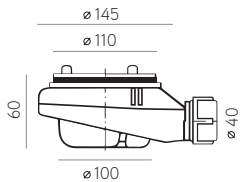

Válvula incluida en el precio
Valve included in the price

Válvula Viega Viega's Drainer

ref. WIE

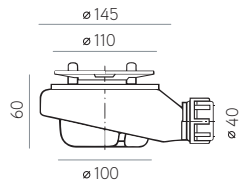

Aprovecha el mínimo espacio
Takes advantage of minimal space

43 puntos pvp
retail price points

Válvula Viega vertical Viega's vertical Drainer

ref. WIEV

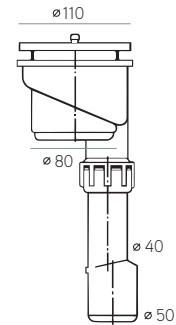

Evacuación de agua vertical
Vertical water drainage valve

62 puntos pvp
retail price points

12

REJILLAS ST-ONE / ST-ONE COVERS

Diseño exclusivo en acero
inoxidable AISI 316
Exclusive design in stainless
steel AISI 316

Rejilla Acero Inox Stainless steel cover

13 x 13 cm



ref. REJ01

Rejilla Neo Acero Inox Neo Stainless steel cover

49 x 12 cm



ref. REJN01

Brillo, incluida en el precio*
Glossy, included in the price*

Mate, incluida en el precio*
Frosted, included in the price*



ref. REJ02



ref. REJN02

Color, opcional*
Coloured, optional*

26 puntos pvp
retail price points



ref. REJ03



ref. REJN03

* Precio de la rejilla suelta, consultar.
* Ask for the price of the single cover.

HGM TECHNOLOGY

Platos aligerados / Light shower Trays

Nuestra serie ST-ONE está también disponible en HGM technology. Sus propiedades físico químicas **reducen el peso** de nuestros platos, **mejorando su resistencia** al impacto y al choque térmico, así como **incrementando su duración y calidad**. Esta sinergia entre ambos materiales nos permite mantener nuestros acabados y gama de colores sin prescindir de su pigmentación en masa.

Además, aporta una importante reducción de peso, entorno al 40%, permitiendo un fácil manejo, reduciendo esfuerzos y una **rápida instalación**.

*Our ST-ONE series is available in HGM technology. The chemical properties can **reduce the weight** of our shower trays, improving its **resistance to impact** and thermal shock, as well as **increasing its duration and quality**. This synergy between both materials allow us to maintain the style and wide range, without affecting the colour.*

*The weight has been reduced by nearly 40%, which enables an easy and comfortable installation, reducing effort and **installation time**.*



13

KIT DE REPARACIÓN ST-ONE / ST-ONE REPAIR-KIT



Para la reparación de un panel o plato de la serie ST-ONE.
For the repair of a panel or tray of the ST-ONE series.

41 puntos netos*
*cost price points**

* Portes incluidos
** Shipping charges are included.*

mundilite

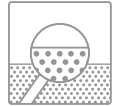

ACABADOS ST-ONE

FINISHES ST-ONE

14



Fabricación en cualquier color RAL/NCS
Choose any RAL/NCS colour

83 puntos pvp
retail price points

Colores Oro (RAL 1036) o Plata (RAL 9022)
Colours Gold (RAL 1036) or Silver (RAL 9022)

106 puntos pvp
retail price points

* Para colores especiales, indicar el color equivalente en la carta RAL o NCS.
For special colours, indicate the RAL or NCS code.

Pergamón

Crema
RAL 9001

Mocca
RAL 1019

Musgo
RAL 7006

Gris Seda
RAL 7044

Cloud
RAL 7040

Gris Polvo
RAL 7037

Gris Cemento
RAL 7046

Antracita
RAL 7016

Negro

NEW

Soft - SO

Skin - SK

Mushroom - MU

Cuero - CU

A close-up view of a synthetic material with a fine, granular, and slightly irregular texture, resembling a fine-grained stone or concrete.

Sintetic - SI

A close-up view of a pizarra (slate) material with a smooth, slightly uneven surface and a subtle, natural-looking grain.

Pizarra - PI

A close-up view of a Gres-Tech material featuring a prominent, regular grid pattern of small, raised squares.

Gres-Tech - GT

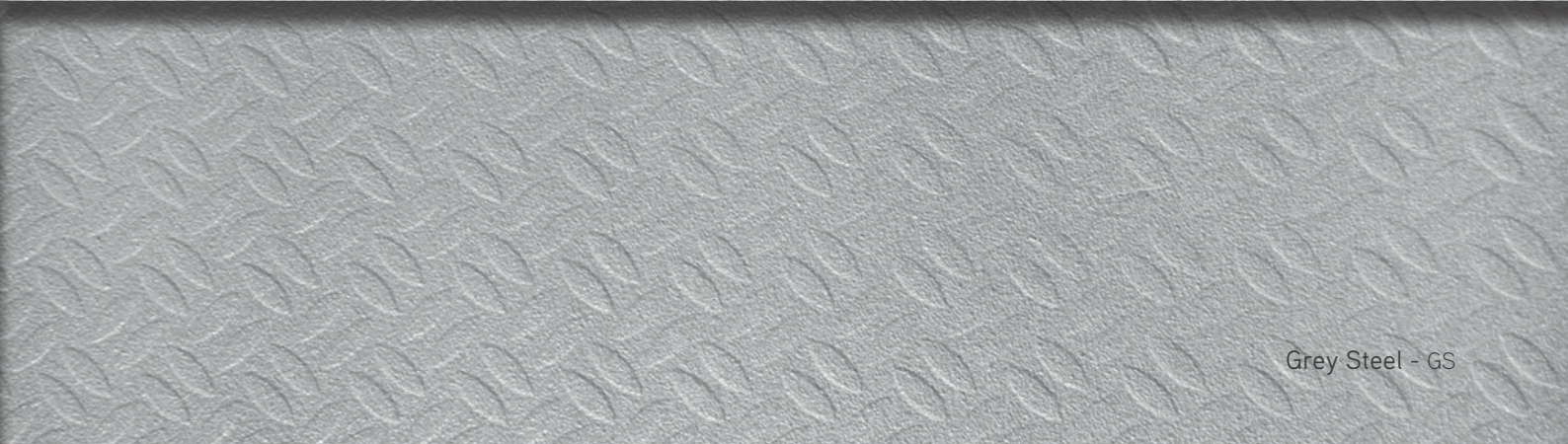
A close-up view of a Grey Steel material with a textured surface consisting of a repeating pattern of small, overlapping, teardrop-shaped motifs.

Grey Steel - GS

A close-up view of a Smooth Wood material with a fine, linear texture that mimics the grain of wood, showing subtle variations in tone and direction.

Smooth Wood - SW

SIN LÍMITES / WITHOUT LIMITS

Si quieres que el espacio de ducha se **ajuste completamente a tu baño**, te proponemos la mejor opción: la fabricación del plato de ducha totalmente a medida. Este tipo de platos garantizan la perfecta adaptación, salvando ángulos, curvas, muros, desniveles, desplazamientos de desagüe...

En Mundilite **nos amoldamos a cualquier espacio**, salvando formas que antes parecían imposibles y **manteniendo sus pendientes de desagüe** intactas para asegurar una total evacuación del agua.

*If you want the shower space to **fit perfectly in your bathroom**, we offer you the best option: manufacturing a fully made-to-measure shower tray. This type of tray guarantees perfect fitting, dealing with angles, curves, walls, unevenness, and displacement of the drain.*

*At Mundilite, **we adapt to any space**, dealing with shapes that previously seemed impossible and **keeping your drain slopes** intact to ensure total water drainage.*

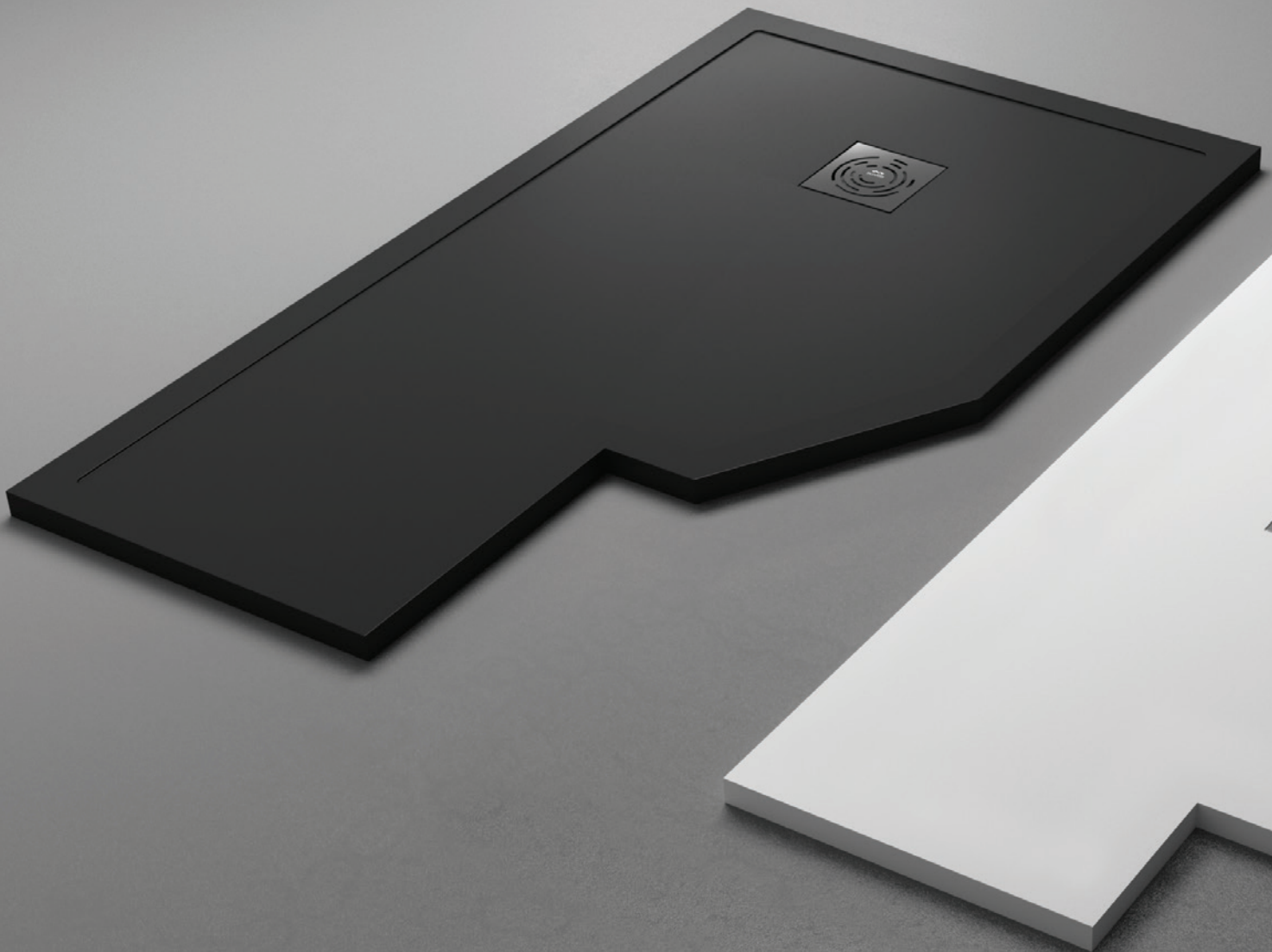

* Solo disponible para modelo LISO, ENMARCADO y UNIC / Only for models LISO, ENMARCADO and UNIC



* Solo disponible para modelo LISO y ENMARCADO / Only for models LISO and ENMARCADO

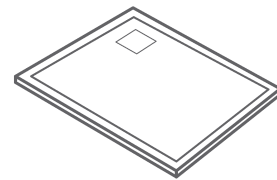

Válvula desplazada
Displaced valve

124 puntos pvp
retail price points

19

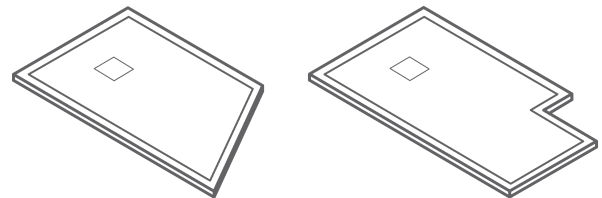

Bordeando salientes o adaptándose al
ángulo de las paredes.
*Bordering ledges or adapting to the angle of
the walls.*

* Consultar precio y viabilidad en fábrica
Consult price and viability in factory





NEW
VENICE

Nuestro nuevo plato Venice juega con el equilibrio y la simetría. Puro minimalismo, perfecto para espacios donde la armonía es la gran protagonista.

Our new Venice shower tray plays with balance and symmetry in pure minimalism, perfect for spaces where harmony is the main theme.

VENICE

ref. STV

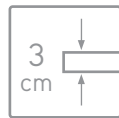
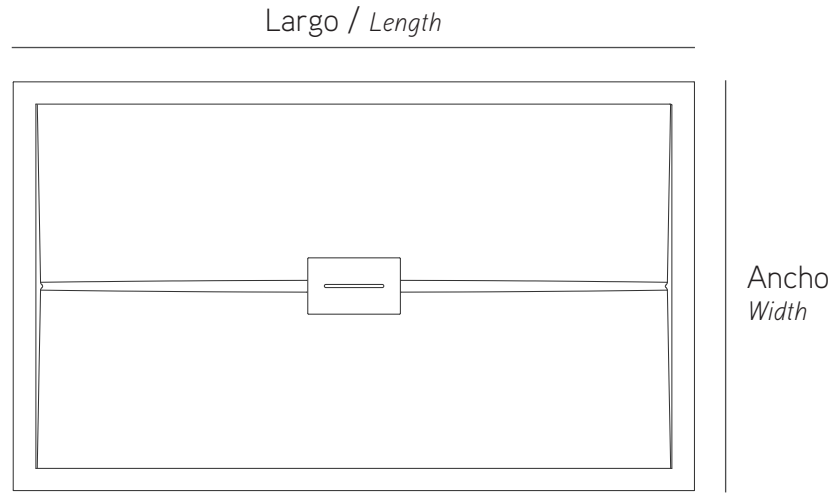

Espesor
Thickness

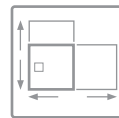

A medida
Made to measure

22

		Largo / Length											
		100 cm	110 cm	120 cm	130 cm	140 cm	150 cm	160 cm	170 cm	180 cm	190 cm	200 cm	210 cm
Ancho Width	70 cm	404	423	442	473	491	511	595	615	632	651	672	691
	80 cm	431	452	474	509	530	552	640	661	682	705	725	747
	90 cm	458	483	506	543	567	592	680	708	731	756	779	803
	100 cm	496	524	552	588	618	645	725	753	779	821	857	889
	110 cm	576	605	630	670	695	740	825	848	873	917	950	990
	120 cm	617	649	680	714	747	780	865	888	911	970	1001	1059

* Variará el marco de 5 a 10 cm dependiendo del tamaño del plato / The frame will vary from 5 to 10 cm depending on the size of the tray.





NEW
UNIC

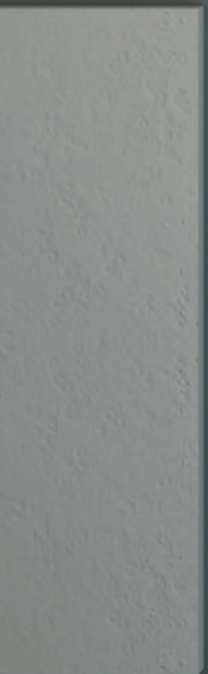
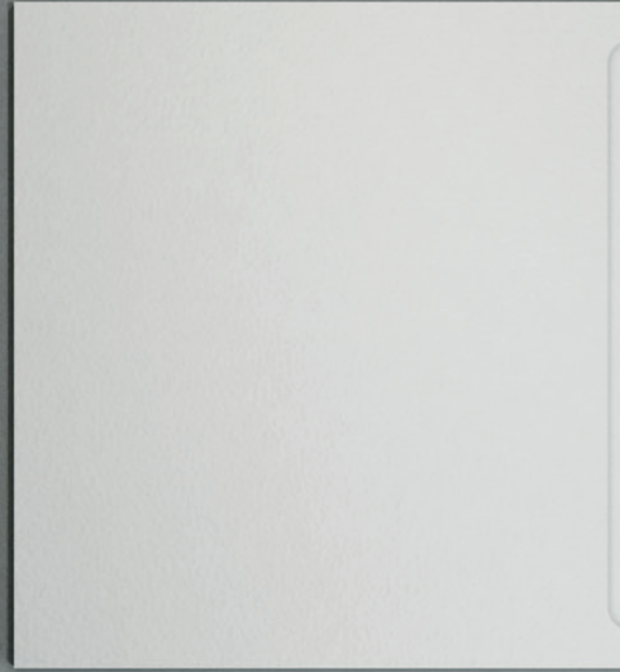
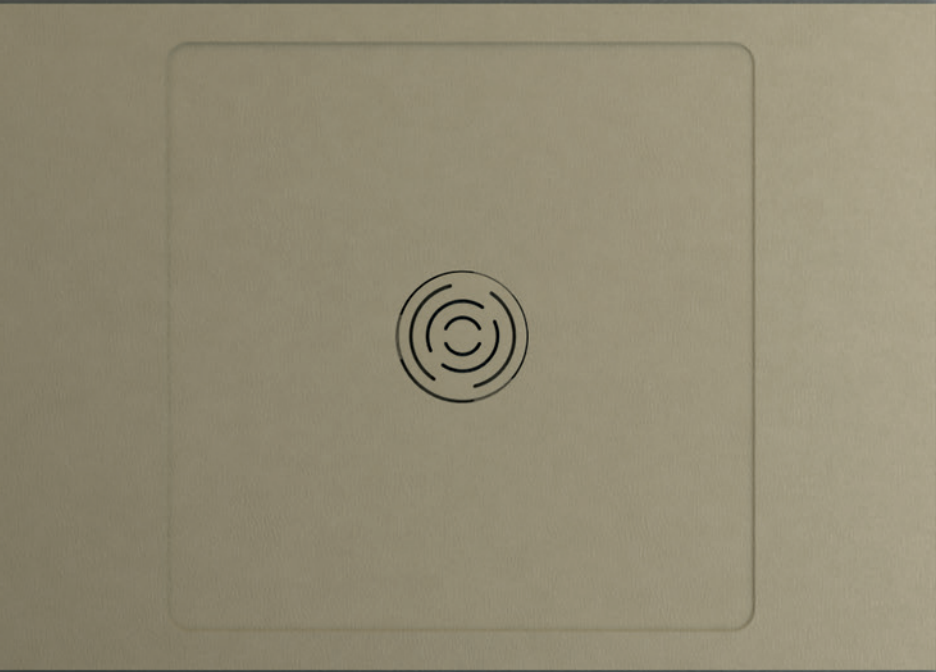



Nuestra nueva serie Unic está diseñada para adaptarse a ti, permitiéndote personalizar tu espacio de ducha por completo, para crear un producto único. Con una geometría limpia es ideal para salvar pilares y falsas escuadras.

Our new Unic series is designed to adapt to you, allowing you to customise your shower space completely, and create a unique product. With clean geometry, it is ideal for dealing with pillars and off-squareness.

CÓMO PERSONALIZAR TU ZONA DE DUCHA HOW TO CUSTOMISE YOUR SHOWER AREA

1º

Acota la zona exterior de tu plato de ducha.
Limit the exterior area of your shower tray.



2º

Selecciona la zona de ducha interior.
Select the interior shower area.

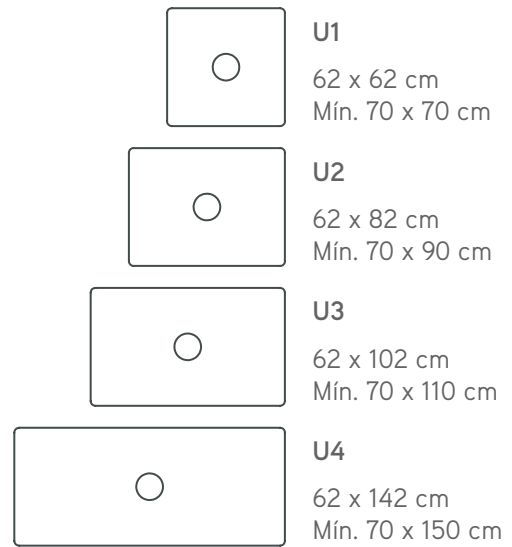

26

3º

Elige su posición dentro de tu espacio de ducha.
Choose its position within your shower space.

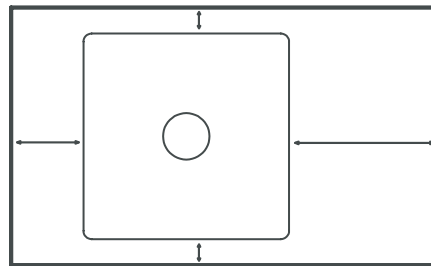

4º

Ahora ya tienes tu plato de ducha personalizado.
Now you have your custom shower tray.

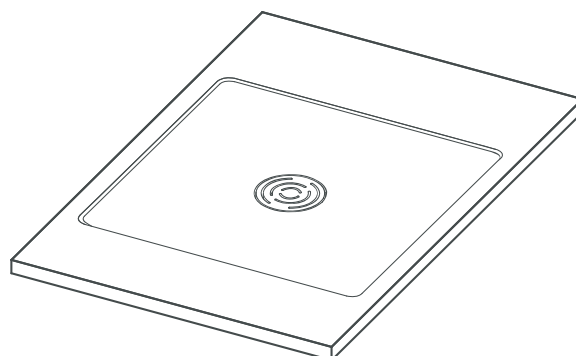



UNIC

ref. STU

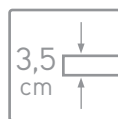

Espesor
Thickness

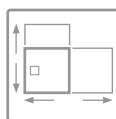

A medida
Made to measure

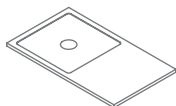

Precio con 1 zona de ducha interior
Price with one interior shower area

Largo / Length

Ancho Width	Largo / Length													
	70-100 cm	110 cm	120 cm	130 cm	140 cm	150 cm	160 cm	170 cm	180 cm	190 cm	200 cm	210 cm	220 cm	230 cm
70 cm	555	579	603	627	651	676	780	804	828	852	878	901	971	995
80 cm	588	618	645	673	698	727	834	862	891	918	946	973	1048	1075
90 cm	624	654	687	717	749	780	890	921	952	985	1015	1044	1123	1152
100 cm	657	693	727	762	797	831	946	980	1015	1051	1084	1119	1198	1233
110 cm	749	787	826	863	902	939	999	1038	1077	1117	1152	1193	1274	1312
120 cm	784	826	867	908	950	992	1056	1098	1139	1176	1223	1263	1349	1392
130 cm	820	863	908	954	998	1042	1110	1155	1201	1245	1291	1336	1427	1471

28

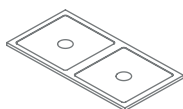

Precio con 2 zonas de ducha interior
Price with 2 interior shower areas

Largo / Length

Ancho Width	Largo / Length									
	140 cm	150 cm	160 cm	170 cm	180 cm	190 cm	200 cm	210 cm	220 cm	230 cm
70 cm	778	802	905	930	954	979	1003	1028	1098	1122
80 cm	825	853	960	989	1017	1043	1072	1100	1173	1201
90 cm	874	905	1016	1046	1078	1109	1141	1171	1248	1278
100 cm	923	958	1072	1105	1141	1175	1210	1244	1325	1359
110 cm	1029	1065	1126	1165	1203	1241	1278	1319	1400	1439
120 cm	1076	1119	1181	1224	1264	1303	1348	1389	1475	1517
130 cm	1125	1169	1237	1281	1327	1371	1417	1463	1553	1598



FICHA DE PEDIDO / ORDER FORM

- Acabados
Finishes

Color / Colour

x

Textura / Texture

- Tamaño del plato de ducha
Shower tray size

Largo / Length

x

Ancho / Width

- Modelo de zona de ducha interior
Interior shower area model

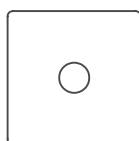

U1

62 x 62 cm
Mín. 70 x 70 cm



U2

62 x 82 cm
Mín. 70 x 90 cm



U3

62 x 102 cm
Mín. 70 x 110 cm



U4

62 x 142 cm
Mín. 70 x 150 cm

* Posibilidad de colocar varios modelos en el mismo plato de ducha a partir 140 cm de largo.

* Possibility of placing several models in the same shower tray over 140 cm in length.

29

- Posición de la zona interior en el plato de ducha.
Position of the interior area in the shower tray.

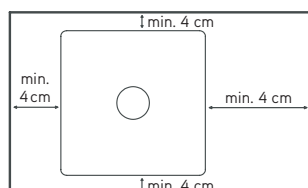

- Mínimo entre la zona de ducha interior y el borde será de 4 cm.

- The minimum space between the interior shower area and the edge will be 4 cm.

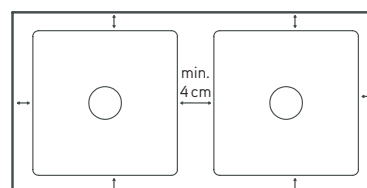

- Mínimo entre varias zonas de ducha interiores será de 4 cm.

- The minimum space between several interior shower areas will be 4 cm.

* Todos los pedidos deberán de ser confirmados por la Oficina Técnica de Mundilite mediante plano.

* All orders must be confirmed by Mundilite's Technical Office with a floor plan.





LISO

Simple y elegante. Todas las características del ST-ONE en un plato moderno y con estilo propio. Técnica y belleza aunadas en un producto único para tu baño.

Simple and elegant. All the characteristics of the ST-ONE in a modern tray with its own style. Technique and beauty combined in a unique product for your bathroom.

LISO / UNFRAMED

ref. STL

Largo / Length

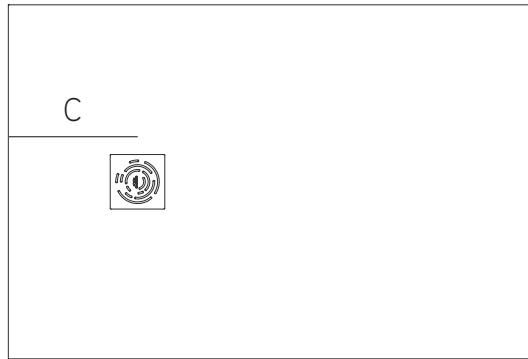

Ancho
Width

C = 30 cm

Medida de largo inferior a 155 cm
For shower trays up to 155 cm

C = 60 cm

Medida de largo superior a 155 cm
For shower trays over 155 cm

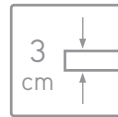

Espesor
Thickness

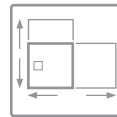

A medida
Made to measure

32

Largo / Long

	60-100 cm	110 cm	120 cm	130 cm	140 cm	150 cm	160 cm	170 cm	180 cm	190 cm	200 cm	210 cm
70 cm	341	362	382	403	425	447	467	489	510	547	579	610
75 cm	350	384	406	430	451	479	514	539	557	589	619	647
80 cm	362	407	430	457	477	512	561	588	606	633	658	685
90 cm	382	435	467	503	516	550	588	623	661	694	737	781
100 cm	426	453	492	535	577	620	661	699	744	790	831	873







MARCO A MEDIDA

MADE TO MEASURE FRAME

ref. STLB

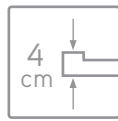

Espesor total
Total thickness

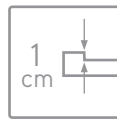

Espesor del marco
Frame thickness

Enmarca tu plato según tus necesidades. Puedes colocarlo de manera perimetral según encaje más en tu espacio. Tu decides cuanto marco necesitas para que encaje en tu diseño.

Frame your tray according to your needs. You can place it around the perimeter as it fits best in your space. You decide how much frame you need to fit your design.

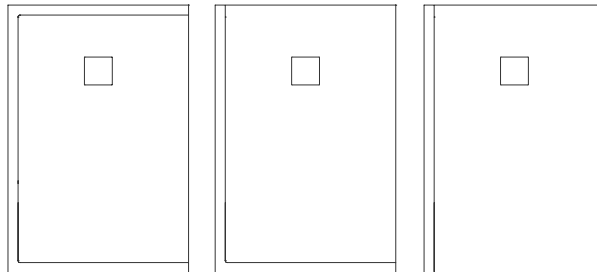

35



KORE

Nuestro renovado plato Kore, con rejilla integrada, de líneas suaves pero con personalidad. La mejor evacuación con toda la elegancia.

Our refreshed Kore tray, with a built-in grille, has lines that are smooth but they have personality. The best drainage with all the elegance in the world.





KORE

ref. STK

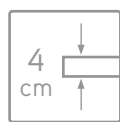
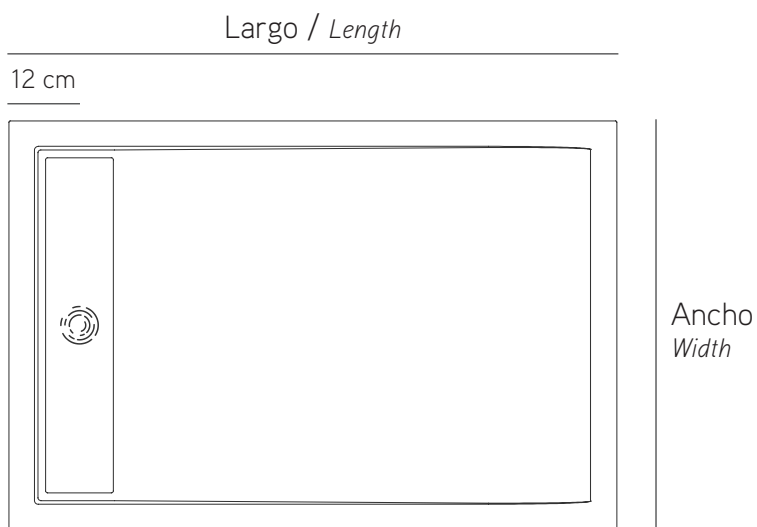

Espesor
Thickness

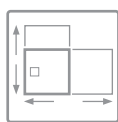

A medida
Made to measure

38

Largo / Length

	90 cm	100 cm	110 cm	120 cm	130 cm	140 cm	150 cm	160 cm	170 cm	180 cm	190 cm	200 cm	
Ancho Width	70 cm	447	462	482	499	516	535	619	634	653	671	688	708
80 cm	469	490	509	527	549	568	656	675	694	716	735	755	
90 cm	492	514	538	558	580	604	692	716	737	759	783	804	
100 cm	538	564	589	615	643	667	764	790	817	843	870	895	

* Variará el marco dependiendo del tamaño del plato / The frame will vary depending on the size of the tray



* Opción de doble válvula Bidrainer / Option of double valve with Bidrainer system

62 puntos pvp / retail price points



ENMARCADO

De simetría pura y sencillez única, el Enmarcado es la mejor opción para espacios con estilo propio. Realizado en una única pieza, sin postizos.

With its pure symmetry and unique simplicity, Framed shower trays are the best option for spaces with their own style. Made in a single piece, without detachable parts.





ENMARCADO / FRAMED

ref. STE

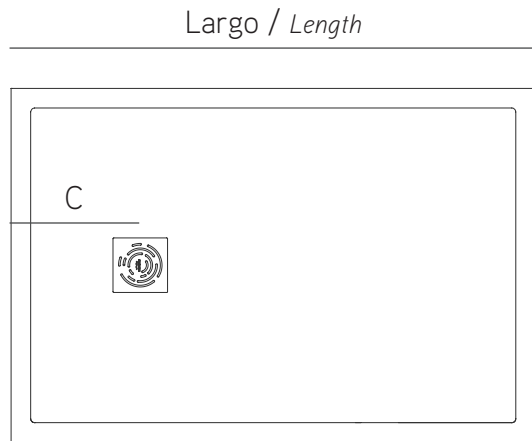

Ancho
Width

C = 30 cm

Medida de largo inferior a 155 cm
For shower trays up to 155 cm

C = 60 cm

Medida de largo superior a 155 cm
For shower trays over 155 cm

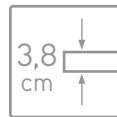

Espeor
Thickness

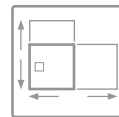

A medida
Made to measure

42

Largo / Length

	60-100 cm	110 cm	120 cm	130 cm	140 cm	150 cm	160 cm	170 cm	180 cm	190 cm	200 cm	210 cm
70 cm	469	499	518	561	581	626	655	689	712	755	791	827
75 cm	483	520	541	579	600	643	676	701	731	773	812	850
80 cm	497	541	564	595	619	658	691	717	750	791	831	872
90 cm	537	561	600	639	664	700	749	783	824	868	930	993
100 cm	588	607	643	667	713	773	843	879	934	976	1054	1129

Ancho
Width







En lugares espaciosos se necesitan platos grandes. Nuestro plato XXL tiene la proporción perfecta adaptada a tu baño.

In spacious places large trays are needed. Our XXL tray has the perfect ratio adapted to your bathroom.





XXL

ref. STX

Largo / Length

max. 230 cm

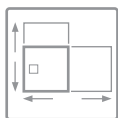
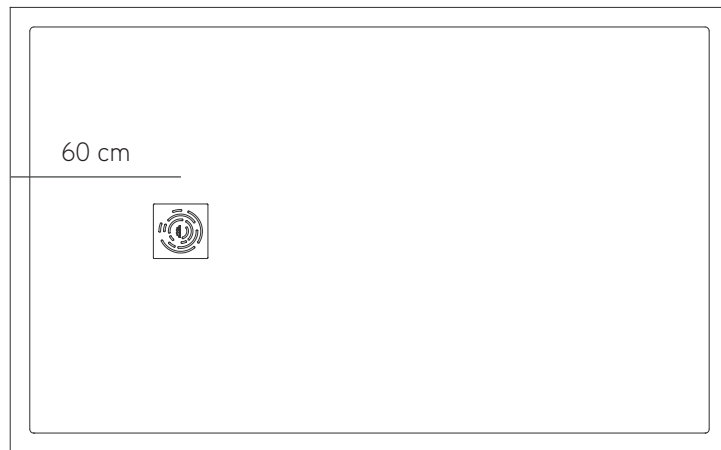

A medida
Made to measure

Opción / Option

LISO
o/or
ENMARCADO

46

Largo / Length

		120 cm	130 cm	150 cm	170 cm	190 cm	210 cm	230 cm
Ancho Width	120 cm	1401	1525	1742	1968	2133	2372	2629
	130 cm	1427	1553	1773	2005	2171	2425	2683

* Consultar texturas / Consult textures





BIZONA





Un diseño único que nos permite agrupar dos espacios de ducha en un único plato. Nuestro plato Bizona tiene carácter propio, unificando minimalismo y vanguardia.

A unique design that allows us to group two shower spaces into a single tray. Our Bizona tray has its own character, unifying minimalism and the avant-garde.

BIZONA

ref. STBI

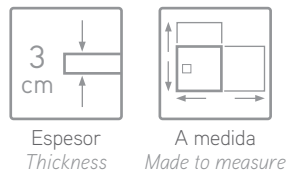
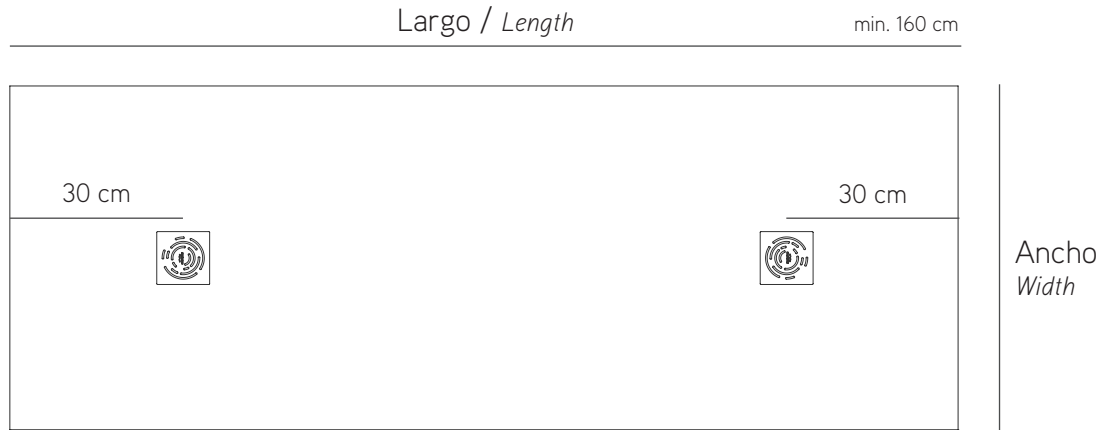

50

Largo / Length

	160 cm	170 cm	180 cm	190 cm	200 cm	210 cm
70 cm	636	658	679	717	749	781
75 cm	685	710	727	760	788	817
80 cm	732	759	777	804	829	855
90 cm	759	793	830	865	907	951
100 cm	830	870	915	960	1002	1043

Ancho Width

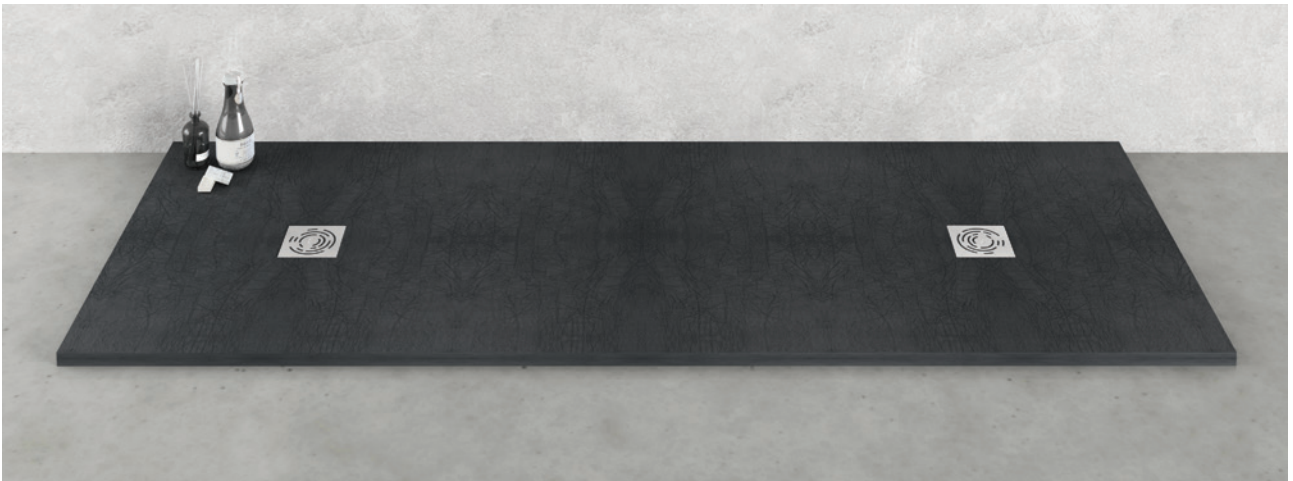





Diferente e innovador, nuestro plato Neo es perfecto para zonas de ducha que requieran una rápida evacuación del agua.

Different and innovative, our Neo tray is perfect for shower areas that require rapid water drainage.

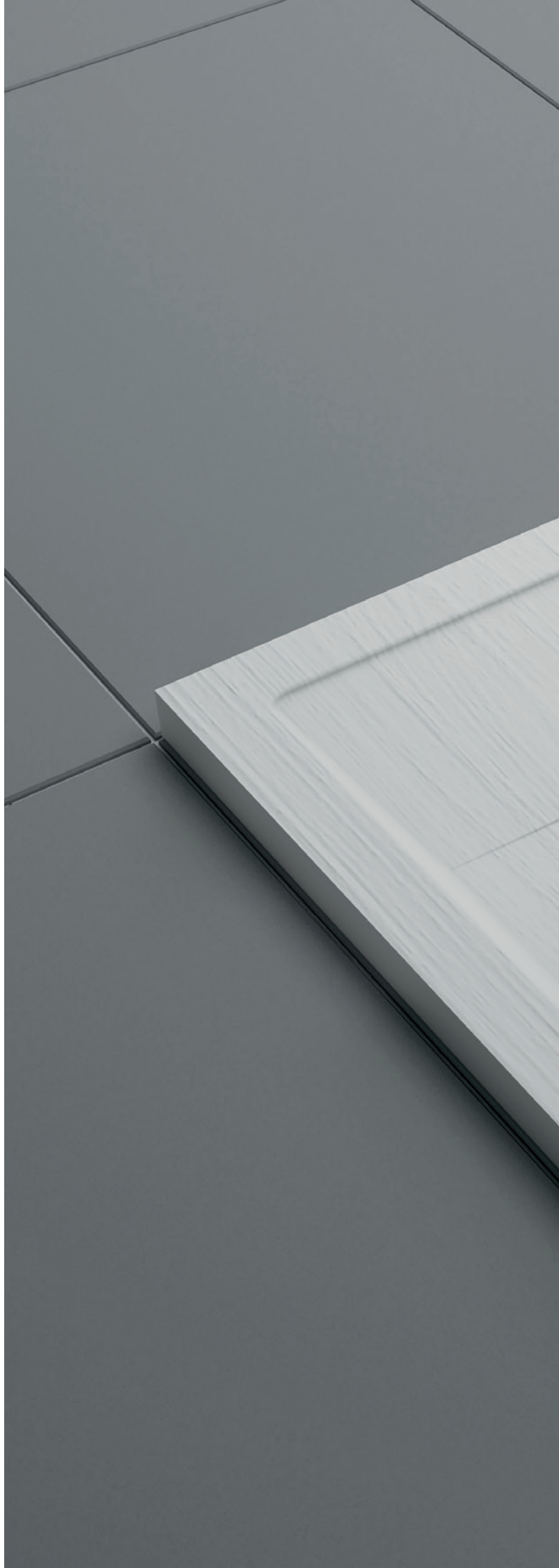

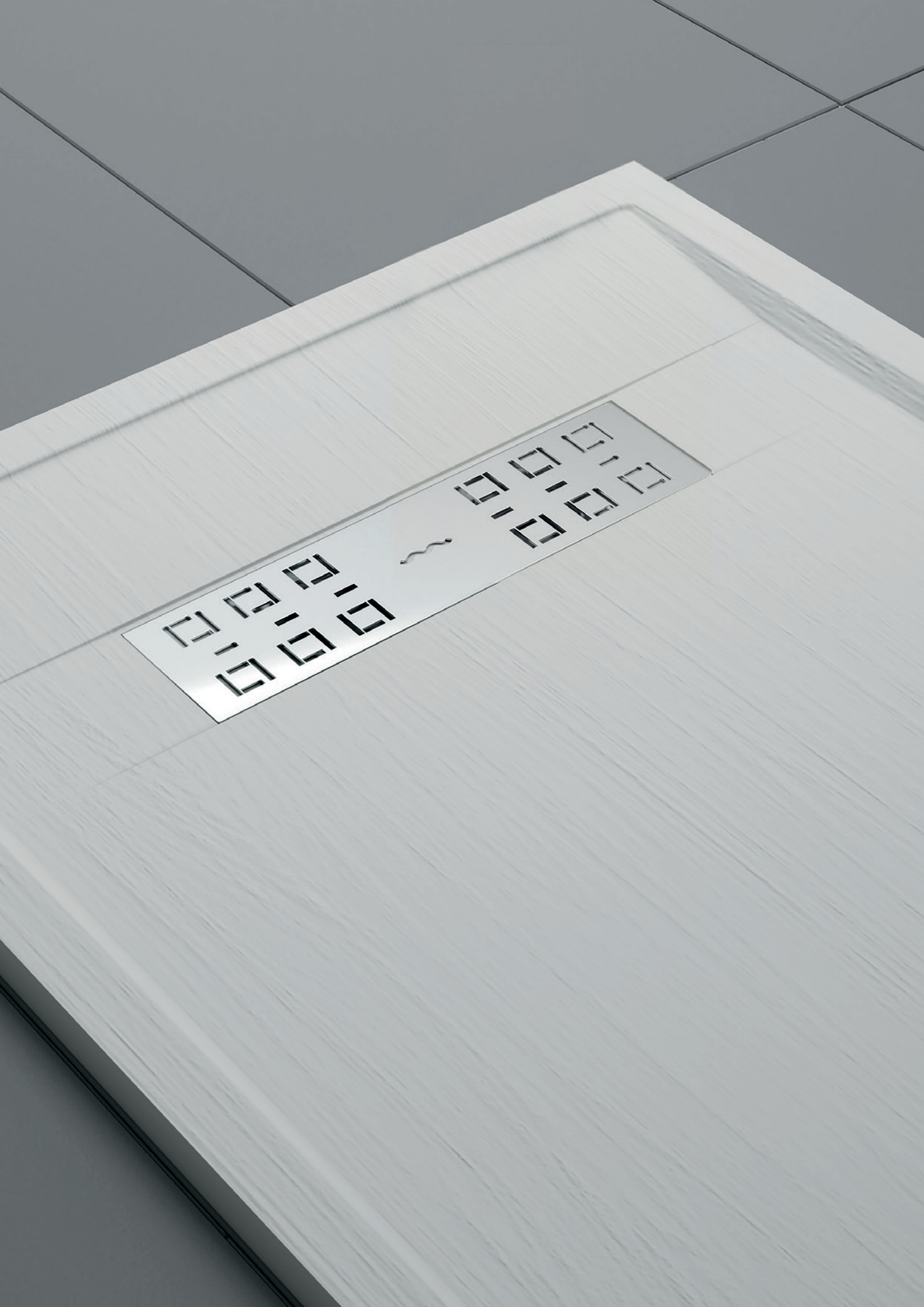

NEO

ref. STN

Largo / Length

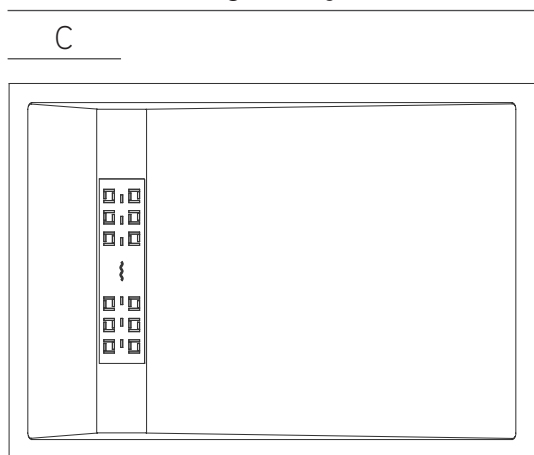

Ancho
Width

C = 30 cm

Medida de largo inferior a 155 cm
For shower trays up to 155 cm

C = 60 cm

Medida de largo superior a 155 cm
For shower trays over 155 cm

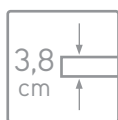

Espesor
Thickness

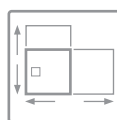

A medida
Made to measure

54

Largo / Length

	120 cm	130 cm	140 cm	150 cm	160 cm	170 cm	180 cm	190 cm	200 cm
70 cm	571	618	640	689	721	758	783	829	870
75 cm	596	636	661	708	740	773	803	850	892
80 cm	622	653	679	725	760	788	825	870	915
90 cm	661	700	730	771	824	861	906	954	1024
100 cm	699	727	777	843	918	958	1018	1064	1147

* Variará el marco dependiendo del ancho del plato / The frame will vary depending on the width of the tray



* Opción de doble válvula Bidrainer / Option of double valve with Bidrainer system

62 puntos pvp / retail price points







ZONA SECADO

La unión perfecta entre funcionalidad y diseño. El plato con zona de secado te permite un espacio extra en tu baño, con medidas totalmente personalizadas que se ajustan a tus necesidades.

The perfect combination of functionality and design. The tray with a drying area gives you an extra space in your bathroom, with customised measures that fit your needs.

ZONA SECADO / DRYING AREA

ref. STS

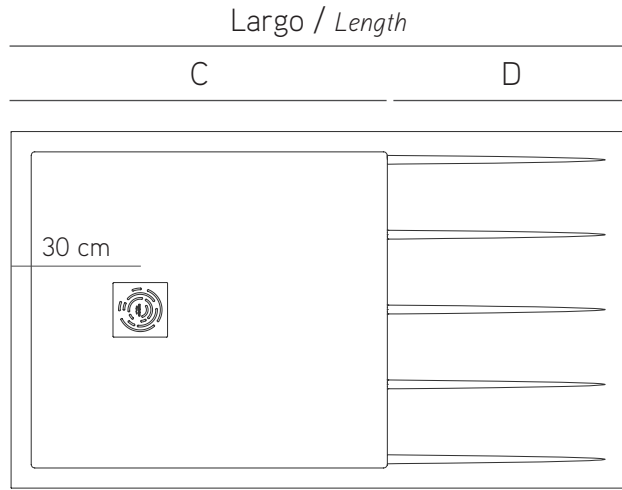

Personaliza tu zona de secado
Customise your drying area

C = 65 cm min.

Zona de ducha / *Shower area*

D = 15 cm min.

Zona de secado / *Drying area*

Ancho
Width

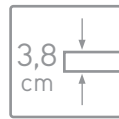

Espesor
Thickness

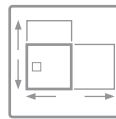

A medida
Made to measure

58

		Largo / Length								
		120 cm	130 cm	140 cm	150 cm	160 cm	170 cm	180 cm	190 cm	200 cm
Ancho Width	70 cm	587	639	658	710	743	781	805	855	896
	75 cm	613	655	679	729	762	797	827	877	921
	80 cm	641	673	700	748	783	813	850	896	942
	90 cm	679	722	753	794	849	889	934	985	1055
	100 cm	729	757	808	874	954	995	1059	1106	1194





ANGULAR

Un clásico de aspecto renovado, con una amplia variedad de medidas y acabados.

A classic with a refreshed appearance, with a wide variety of sizes and finishes.





ANGULAR / ANGULAR

ref. STA

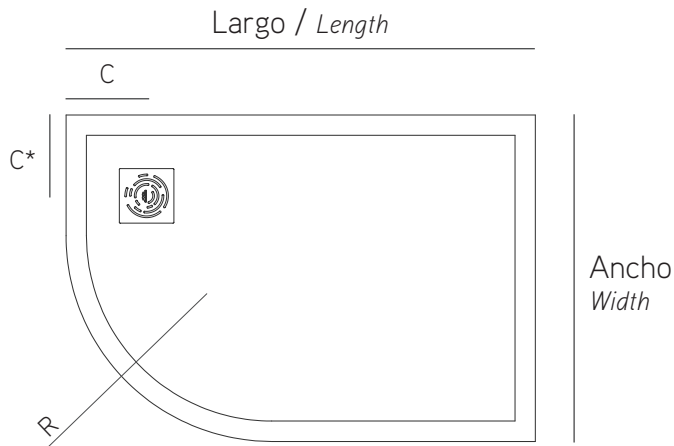

C, C* = 20 cm

Medida de largo inferior a 120 cm
For shower trays up to 120 cm

C, C* = 30 cm

Medida de largo de 120 cm a 150 cm
For shower trays over 120 cm up to 150 cm

C = 60 cm C* = Ancho/2 Half width

Medida de largo superior a 150 cm
For shower trays over 150 cm

R = 504 o/or 550

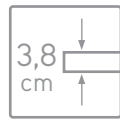

Espesor
Thickness

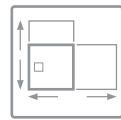

A medida
Made to measure

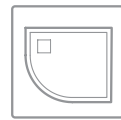

Izquierda
Left
ref. SX

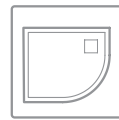

Derecha
Right
ref. DX

62

Largo / Length

	70 cm	75 cm	80 cm	90 cm	100 cm	110 cm	120 cm	130 cm	140 cm	150 cm	160 cm	170 cm	180 cm	190 cm	200 cm
70 cm	-	*511	*525	*557	*585	*624	*648	*701	*726	*783	*821	*861	*890	*943	*989
75 cm	*504	*522	*543	*568	*605	*651	*676	*723	*750	*803	*840	*879	*914	*966	*1015
80 cm	*516	*535	354	582	623	676	708	743	773	824	863	896	937	989	1039
90 cm	*544	*564	596	414	671	701	750	798	829	878	936	980	1031	1085	1164
100 cm	*568	*596	628	673	503	759	803	834	891	966	1054	1099	1168	1221	1316

- Consultar con fábrica / Consult factory

* Radio 380 / Radius 380





PANELES PUR/ PUR PANELS

ref. PST

		Largo / Long							
		90 cm	110 cm	130 cm	150 cm	170 cm	190 cm	210 cm	230 cm
Ancho Width	40 cm	96	109	132	149	168	174	177	210
	45 cm	106	128	149	167	188	202	217	255
	50 cm	116	139	165	182	209	222	247	285
	55 cm	130	153	181	203	232	249	269	307
	60 cm	139	167	197	221	253	268	296	333
	65 cm	161	181	210	234	266	278	307	345
	70 cm	175	195	222	245	276	290	320	358
	75 cm	195	210	236	258	289	303	330	368
	80 cm	209	222	246	269	299	314	343	381
	90 cm	241	255	284	307	347	368	408	451
	100 cm	274	287	322	345	396	422	473	516

* Por enviar paneles sueltos se cobrará un importe neto de 15 puntos en concepto de transporte.
For orden of panels alone, 15 points will be charge.

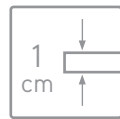

Espesor
Thickness

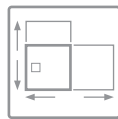

A medida
Made to measure

64

La solución perfecta para cambiar la bañera por la ducha
 The perfect solution to change a bathtub for a shower





RAMPA / ACCESS RAMP

ref. RST

Rampa para una mejor accesibilidad. Misma textura que el plato.
Easy access ramp. Same texture of the shower tray.

* Para pedidos por separado, consultar.
** Ask for separate orders.*

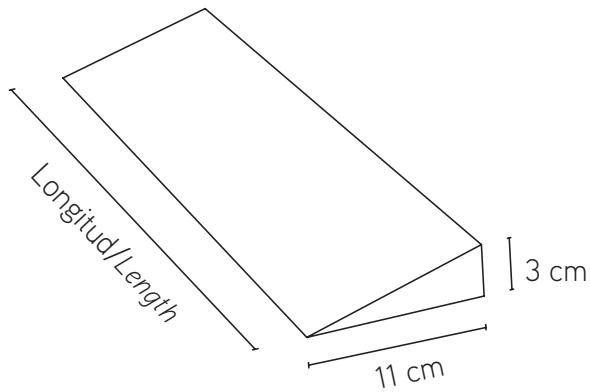

0,93 ^{puntos} / _{points} / cm lineal

Incremento por corte en inglete
Increases by miter cutting

21 puntos pvp
retail price points

66

ZÓCALO / ELEVATED EDGING

ref. ZST

Zócalo de elevación para conseguir altura.
Elevated edging to raise height.

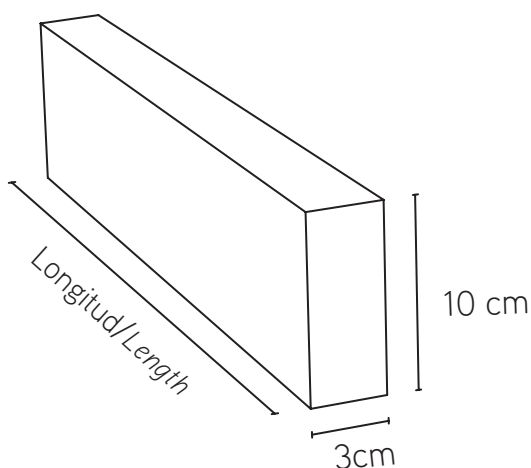

0,52 ^{puntos} / _{points} / cm lineal

Incremento por corte en inglete
Increases by miter cutting

21 puntos pvp
retail price points

* En caso de tener que enviar rampa o zócalo suelto se cobrará un importe neto de 12 puntos en concepto de transporte.
** For orden of access ramp or elevated edging alone, 12 points will be charge.*



EXPOSITOR / DISPLAY STAND

ref. EXP

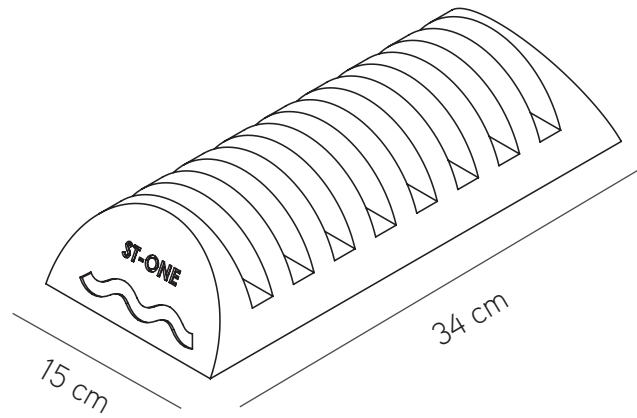

68

	Plato de ducha Shower tray		Placa						
	Liso	Enmarcado							
Textura Texture	Sintetic	Cuero	Smooth wood	Skin	Grey steel	Gres-tech	Mushrooom	Pizarra	Soft
Color Coulour	Cloud	Mocca	Chocolate	Antracita	Cemento	Pergamon	Vison	Crema	Blanco

Expositor + 8 muestras de colores y texturas (16,5 x 23,5 cm)
 Display stand + 8 samples of colours and textures (16,5 x 23,5 cm)

62 puntos
points

- Consultar con fábrica / Consult factory



CONDICIONES GENERALES DE VENTA

1 Condiciones generales

Todos los pedidos que se efectúen a Mundilite deben cumplir las siguientes condiciones contractuales generales, no contemplándose ningún otro acuerdo sin el reconocimiento explícito y por escrito de Mundilite. La realización de un pedido supone la aceptación total y expresa de las condiciones contractuales enumeradas a continuación.

2 Pedidos

Tanto las descripciones de los productos así como las fotografías, catálogos, tarifas y cualquier tipo de información impresa o digital, deben de considerarse como de mero carácter informativo, en ningún caso vinculantes, ni con carácter contractual, exceptuando el presente documento de condiciones generales de venta. Mundilite se reserva el derecho de cambiar o modificar sin previo aviso, de forma total o parcial cualquiera de sus productos, o las características de los mismos, siempre que lo considere necesario para el desarrollo técnico o la mejora del artículo.

Los pedidos serán considerados firmes a su recepción, no aceptándose anulaciones o modificaciones en los mismos, en caso de anulación o modificación, la empresa se reserva el derecho de adeudar los gastos que conlleve dicha anulación o modificación. Todos los pedidos deben de ser enviados vía correo electrónico, por escrito, para evitar las posibles interpretaciones erróneas.

Nuestros productos pueden tener una tolerancia +/- de 1% respecto a las dimensiones especificadas, debido a las propiedades del material utilizado en el proceso de fabricación. Indicar siempre la medida del ancho y del largo debido a que la posición del desagüe puede variar.

3 Precios

Los precios de la tarifa están indicados en puntos.

Los precios son los indicados en la tarifa vigente en el momento de realizar el pedido. No obstante, en caso de un aumento de costes de las materias primas o cualquier otro coste indirecto, Mundilite se reserva el derecho de corregir dichos precios para ajustarlos, incluso sin previo aviso. Los precios de tarifa no incluyen los impuestos vigentes, estos impuestos serán incluidos en factura, siempre a cargo del comprador. La presente lista de precios, anula cualquier precio vigente u oferta anterior.

4 Condiciones de pago

Si no existe otro acuerdo vigente, el pago se efectuará por anticipado. En caso de retraso en el pago, Mundilite, no estará obligada a efectuar ninguna entrega. Las facturas emitidas por el propietario de la marca Mundilite, originadas por prestación de servicios o entrega de productos, se abonarán por el total del importe de las mismas, en la fecha pactada y conforme a los plazos, condiciones y medios acordados. Cualquier importe impagado en su fecha de vencimiento devengará de forma automática, sin previo aviso al tipo de interés legal mas un 3% de diferencial mas los gastos ocasionados por el impago.

5 Reserva de la propiedad

La mercancía es propiedad de Mundilite, hasta el momento de la liquidación total de su importe, y el comprador faculta a Mundilite, en caso de impago o incumplimiento, a la retirada de los productos de su establecimiento o instalaciones. En caso de retirada del producto por incumplimiento, el comprador, tendrá la obligación de responder de todos los gastos ocasionados por dicha retirada.

6 Transporte y embalajes

La mercancía se enviará libre de embalajes, siempre que el

pedido, se ajuste al embalaje estándar de Mundilite. Cuando se tenga que dotar de embalajes que no son de tipo estándar, porque las circunstancias así lo requieran, éstos serán a cargo del comprador.

En el momento de la entrega, el comprador, tiene la obligación, de comprobar el embalaje, así como la mercancía, siendo indispensable hacer constar en el albarán de entrega del transportista cualquier anomalía, avería, menoscabo, golpe, rotura o mercancía incompleta. Cualquiera de estas anomalías debe ser comunicada por escrito a Mundilite dentro del plazo de las 24 horas siguientes de la recepción de la mercancía. La mercancía siempre viaja por cuenta y riesgo del destinatario, incluso aunque el envío corra a cargo de Mundilite.

Los portes están incluidos en el precio, siempre y cuando el importe neto sea superior a 180 puntos y la entrega sea realizada dentro de la península ibérica.

Para envíos fuera de la península, tanto las condiciones de entrega como los portes serán acordados previamente.

7 Devoluciones

Como norma general, no se admiten devoluciones. En el caso excepcional de una devolución, ésta deberá ser debidamente solicitada por escrito. No se aceptará ninguna devolución que previamente no haya sido autorizada por escrito por parte de Mundilite. En el caso de que la devolución fuera autorizada por Mundilite se cargarán al Cliente los gastos de transporte, gestión y revisión. En ningún caso se aceptará la devolución de ningún producto fabricado a medida, o con acabados o características especiales.

8 Garantía

Todos los productos Mundilite, están garantizados según la normativa europea vigente, por un plazo de 24 meses, desde la fecha de entrega. La garantía cubre las partes que en el momento de la entrega, presenten anomalías o defectos de fabricación o de material defectuoso. Estas anomalías deberán ser comunicadas por escrito, en cuyo caso y previo estudio, Mundilite se compromete únicamente a enviar para su sustitución, los elementos que presenten dicha merma. La garantía, siempre hará referencia a la pieza defectuosa, que se enviará al domicilio del cliente que recibió la expedición a portes pagados, y en ningún caso a la instalación de la misma, con la salvedad que dicha instalación haya sido realizada por el S.A.T autorizado por Mundilite, en cuyo caso también cubrirá la mano de obra de sustitución del elemento defectuoso. Queda excluida cualquier otra reclamación por parte del destinatario.

La garantía no cubre en ningún caso, defectos provocados por un montaje incorrecto o efectuado por personal que carezca de autorización expresa y por escrito efectuada por Mundilite autorizando el montaje, así como, el uso inadecuado o impropio de los productos, malos tratos, utilización de productos de limpieza agresivos, mantenimiento inadecuado, suciedad, o el incumplimiento de las condiciones de instalación facilitadas por el fabricante.

La garantía hace referencia única y exclusivamente a la sustitución del material que presente anomalías previamente reconocidas por escrito por Mundilite, en el domicilio donde fue hecha la entrega del producto, quedando entendido y expresamente convenido todo lo anterior, y con exclusión de cualquier otra compensación, daños o interés.

9 Impuestos

Siempre a cargo del comprador según la legislación vigente.

10 Jurisdicción

Ambas partes aceptan todas las condiciones derivadas del presente contrato y se someten a ellas, con renuncia expresa a sus propios fueros en caso de existir, a la jurisdicción de los Juzgados y Tribunales de Valencia como únicos órganos competentes.

*Tarifa válida salvo error tipográfico

1 General conditions

All orders must be made to Mundilite meeting the following conditions of contract not generally contemplating, any other agreement without the express written acknowledgment of Mundilite. The placement of an order implies the acceptance and expresses total contractual conditions listed below.

2 Orders

Both product description and photographs, catalogues, price lists and any type of printed or digital, must be regarded as mere information, in no case binding or contractual basis, with the exception of the conditions here in of sale.

Mundilite reserves the right to change or modify these without notice, the whole or in part of any of its products, or the characteristics there of, provided that it's deemed necessary for technical development or article improvement

Orders will be considered firm to receipt, not accepting cancellations or modifications there of, in case of cancellation or modification, the company reserves the right to charge the expenses it incurs such as cancellation or modification. All orders must be email, in writing, to avoid possible misinterpretation.

Our products can have a tolerance of +/- 1% with respect to the specified dimensions, due to the properties of the material used in the manufacturing process.

In the ST-ONE models indicate the width and length. The valve position vary.

3 Prices

The price list is in points.

Prices are indicated in the current rate at the time of ordering. However, in case of an increase in material costs premiums or other indirect costs, Mundilite reserves the right to amend these prices to fit, even without notice. Prices do not include tax rates, those taxes will be included in invoice, provided to the buyer. This price list supersedes any price current or previous offer.

4 Payment

If no other agreement is in place, payment will be made in advance. In case of any overdue payment, Mundilite will not be required to make any deliveries. Invoices issued by the brand owner Mundilite, arising from the provision of services or product delivery will be paid the total amount there of, on the agreed date and in accordance to the terms, conditions and means agreed. Any amount not paid on its due date will accrue automatically, without notice to legal interest rate plus a 3% differential over the expenses incurred for non-payment.

5 Retention of title

The merchandise remains the property of Mundilite, until time of the total settlement of the invoice, and Mundilite empowers the buyer in case of default, the withdrawal of the products from its establishment or facilities. In the case of withdrawal of the product for breach, the buyer, will be required to account for all the costs caused by such removal.

6 Transport and packaging

The goods will be sent free of packaging provided that the request complies with the standard packing of Mundilite. When it is necessary to provide packaging that is not the standard type, that the circumstances have required so, this will be charged to the purchaser. At the time of delivery, the buyer has the obligation, to verify the packaging, as well as the merchandise, being necessary to state in the carrier's

delivery note any failure, mal function, damage, blow, breakage or incomplete merchandise. Either of these anomalies must be communicated to Mundilite in writing with in 24 hours after receipt of the goods. The goods always travel at the risk of the recipient, even if the shipment is carried out by Mundilite. Shipping charges are included in the price, even when the net amount exceeds 180 points and delivery can be performed within the Iberian Peninsula. Bath screens prices are exworks, if shipping destination, will suffer an increase of 40 points net volumetric weight in concept by the buyer, per unit. Except for certain series whose fares are 10 points for shipments below 300 points. For shipments outside the peninsula, both delivery conditions as shipping costs will be agreed in advance.

7 Returns

As a general rule, no returns. In the exceptional case of a return, it must be duly requested in writing. We do not accept any returns that have not previously been authorized in writing by Mundilite. In the case that a refund being authorized by Mundilite the customer will be charged the shipping, management and review cost. In any case the return of any product made to measure / custom made or finishes or special features will not be accepted.

8 Warranty

All Mundilite products are guaranteed. According to the current European regulations, for a period of 24 months from the date of delivery. The warranty covers parts that at the time of the delivery, showed abnormalities or defects in workmanship or defective material. These anomalies must be communicated in writing, in which case and prior to study Mundilite will agree only to send for replacement elements presenting this decline. The warranty will always refer to the defective part being sent to the address of receipt client issuing prepayment, and in no case to the facilities of the same, with the exception that the fitting was carried out by SAT authorized by Mundilite, in which case it covers the labor of the defective element replacement. Any further claim by the recipient is excluded. The warranty does not cover in any case, defects caused by improper assembly or done by personnel lacking expressly authorized in writing made by Mundilite authorizing its assembly as well as improper use or improper products, abuse, use of aggressive cleaning products, improper maintenance, dirt, or failure of compliance with the fitting conditions / system provided by the manufacturer. The guarantee applies exclusively to the replacement of the material exhibiting anomalies previously acknowledged in writing by Mundilite at the address where the product delivery was made being specifically understood and agreed all above, and excluding any other compensation, damages or interest.

9 Taxation

Will always be paid by the buyer. According to the law.

10 Jurisdiction

Both parties agree to all conditions arising of this contract and submit to them, waiving expressing their own jurisdictions if any, to the jurisdiction of the Courts of Valencia as sole jurisdiction.

* Valid tariff except for typographic errors

Aviso legal

Mundilite se reserva el derecho a aportar modificaciones parciales o totales e incluso la retirada de tarifa sin necesidad de previo aviso, y sin obligación de suministro de los modelos presentados. Los datos y características que aparecen en esta tarifa no son vinculantes para el fabricante y/o distribuidor. Queda totalmente prohibida la reproducción total o parcial de esta tarifa sin el consentimiento del propietario de la marca.

Disclaimer

Mundilite reserves the right to make changes and even the partial or total removal of the price list without prior notice and without the obligation to supply the details and features shown in this price list are not binding for the manufacturer and / or distributor. It is prohibited to reproduce all or part of this price list without the consent of the trademark owner.

PLATOS DE DUCHA
SHOWER TRAYS



TARIFA - PRICE LIST



Apdo. de Correos 72
C/ Malvasia Parc. 9 y 11 - Polígono Industrial Pino Blay
46380 Cheste - Valencia - Spain
Telfs +34 96 251 28 94 / +34 96 070 23 81
Email: admon@mundilite.com

